

With 12 GA. Steel Stiffener

Curve Representation

- A = 15 PSF
- B = 20 PSF
- C = 25 PSF
- D = 30 PSF

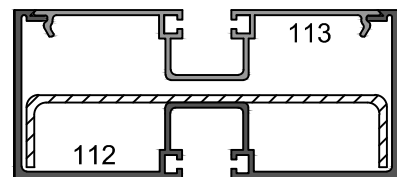
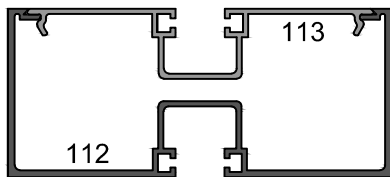
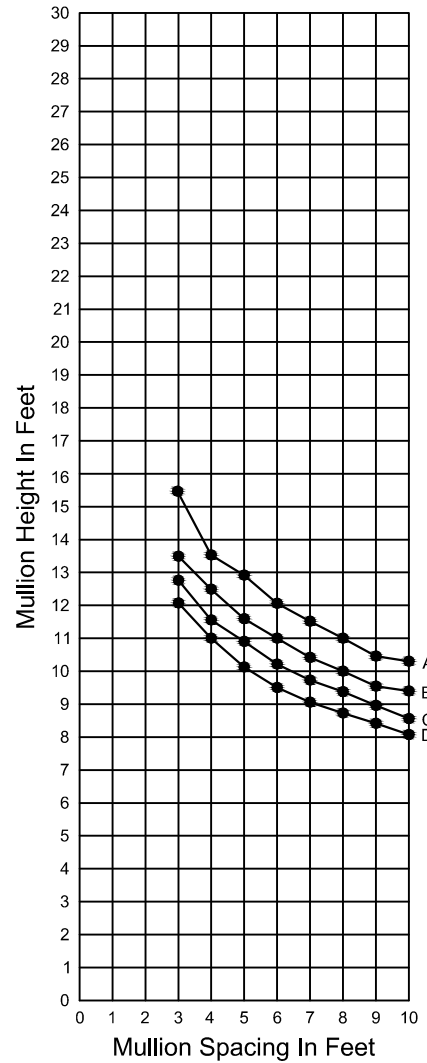
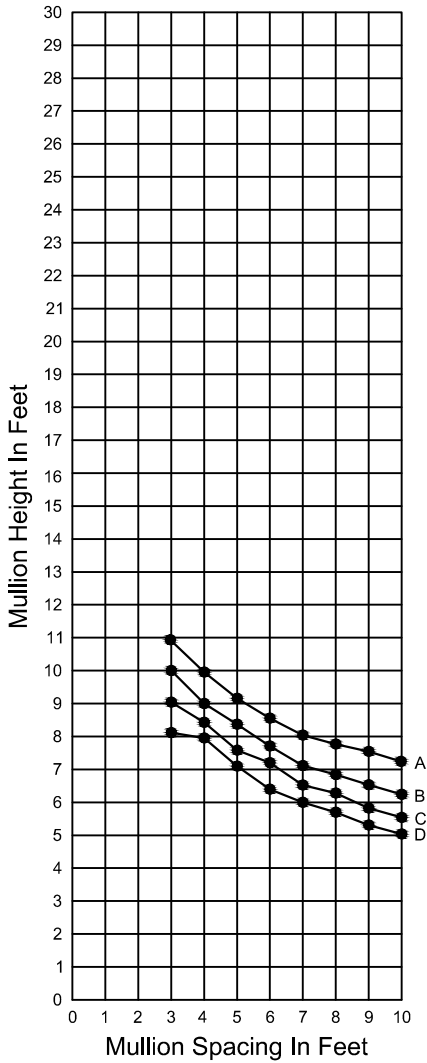

With 12 GA. Steel Stiffener

Curve Representation

- A = 15 PSF
- B = 20 PSF
- C = 25 PSF
- D = 30 PSF

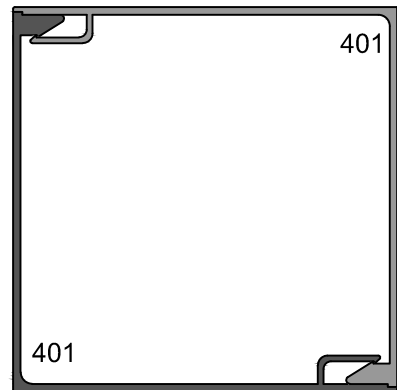
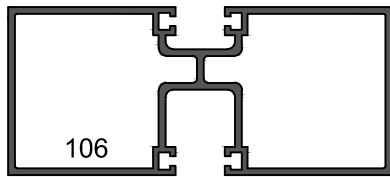
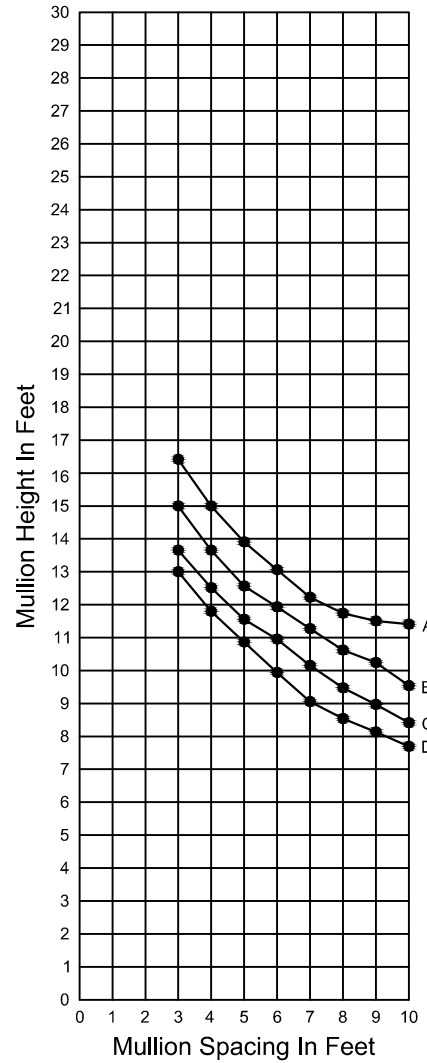
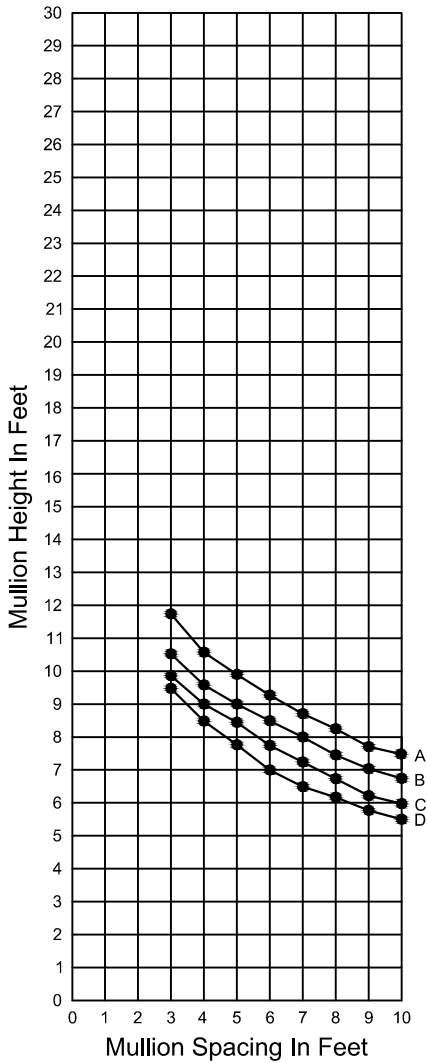

Curve Representation

- A = 15 PSF
- B = 20 PSF
- C = 25 PSF
- D = 30 PSF

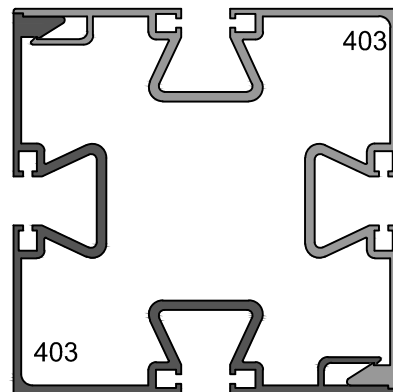
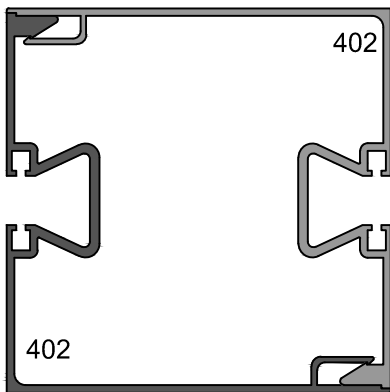
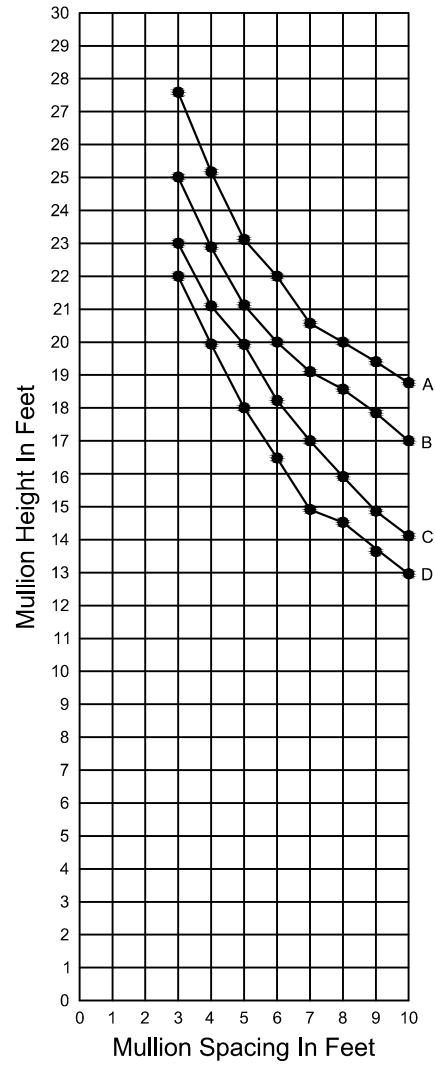
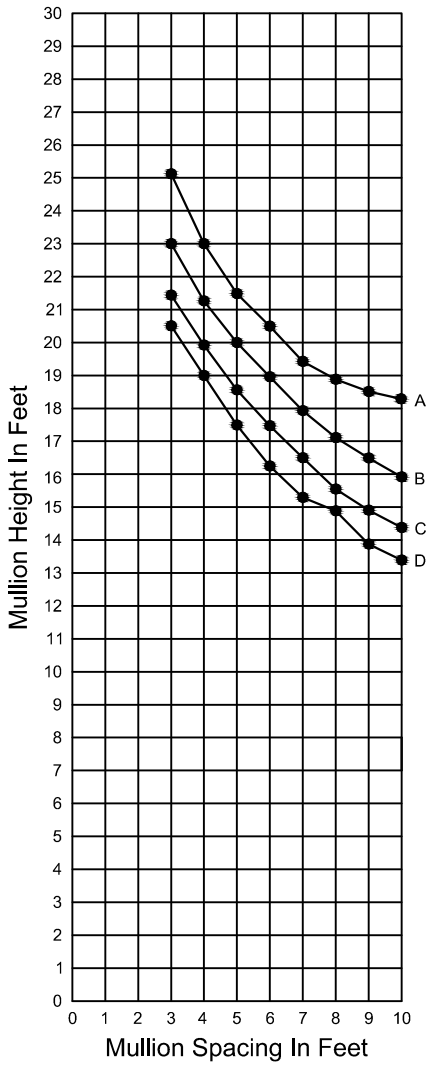

**Curve Representation**

- A = 15 PSF
- B = 20 PSF
- C = 25 PSF
- D = 30 PSF

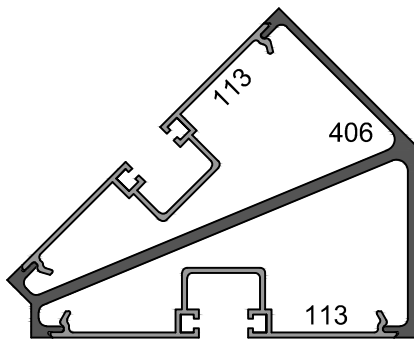
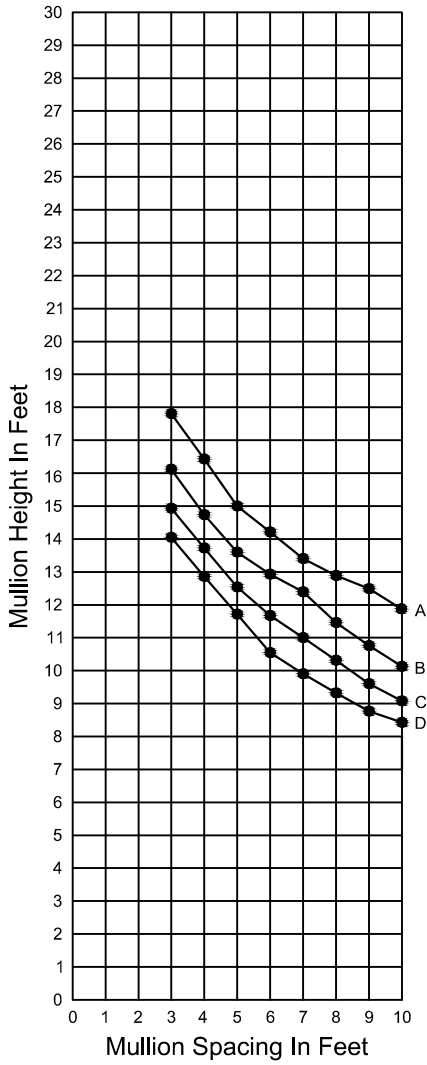

Curve Representation

- A = 15 PSF
- B = 20 PSF
- C = 25 PSF
- D = 30 PSF