











ITEM NUMBER	DRAWING	DESCRIPTION
211		Head Can
210		Head Can Filler
207		Sill Can
208		Sill Can Insert
809		Glass Stop for Sill Can
214		Horizontal w. Screw
809-1		Glass Stop for Horizontal
213		Flat Filler
212		Wall Jamb
206		Intermediate Vertical
216		Horizontal Clip







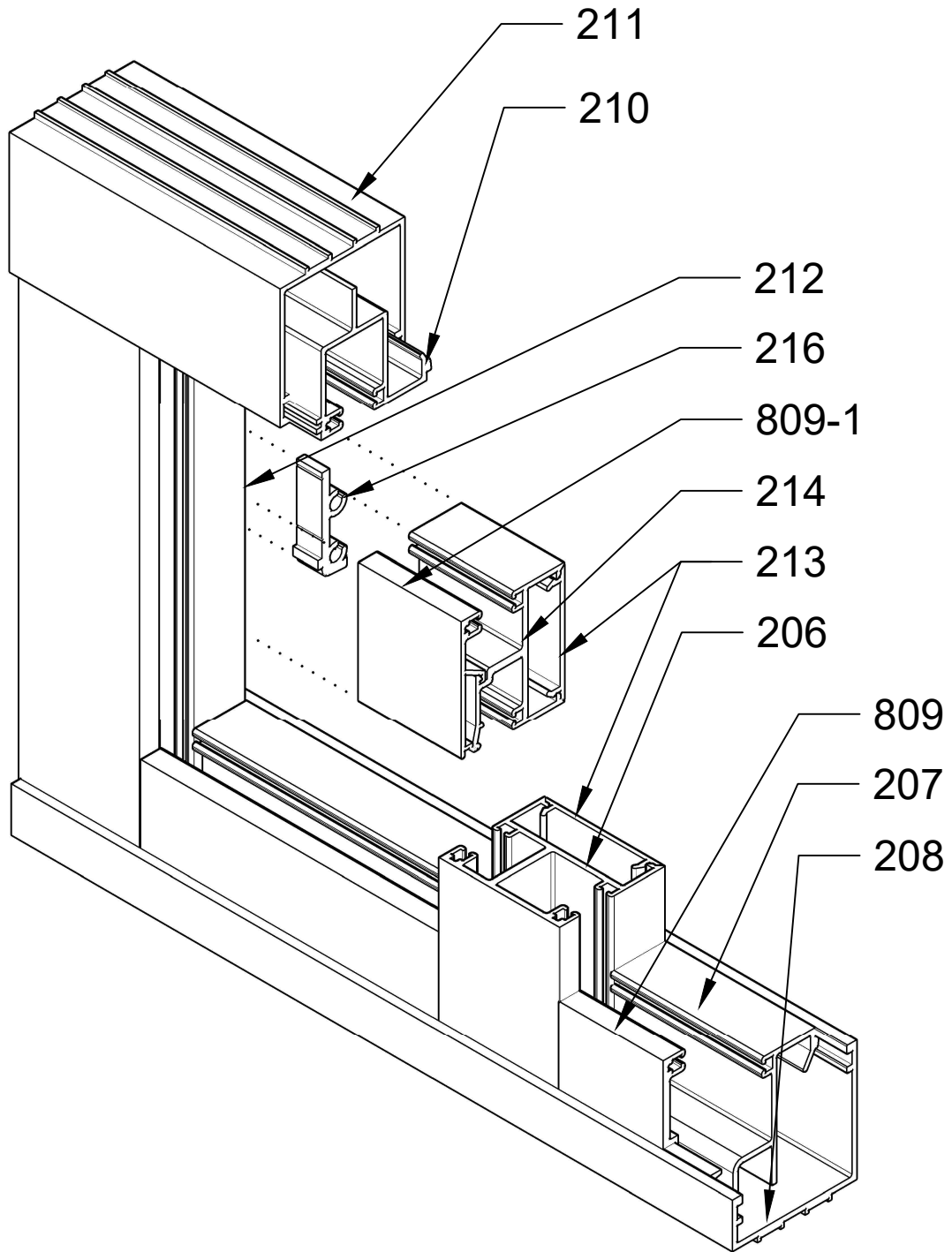
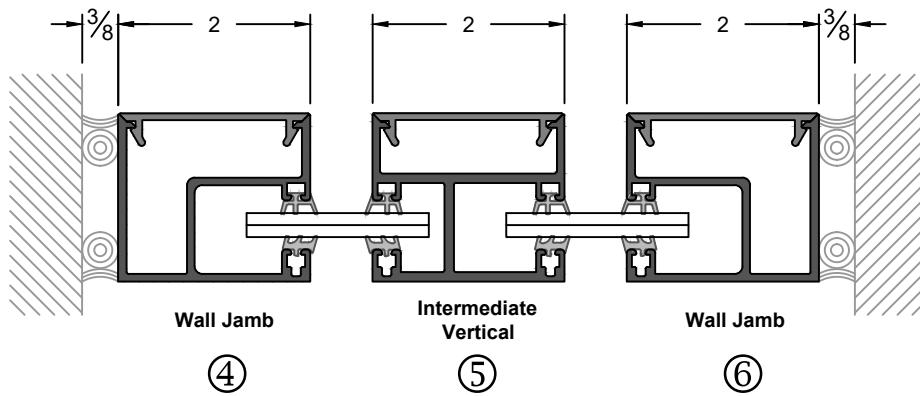
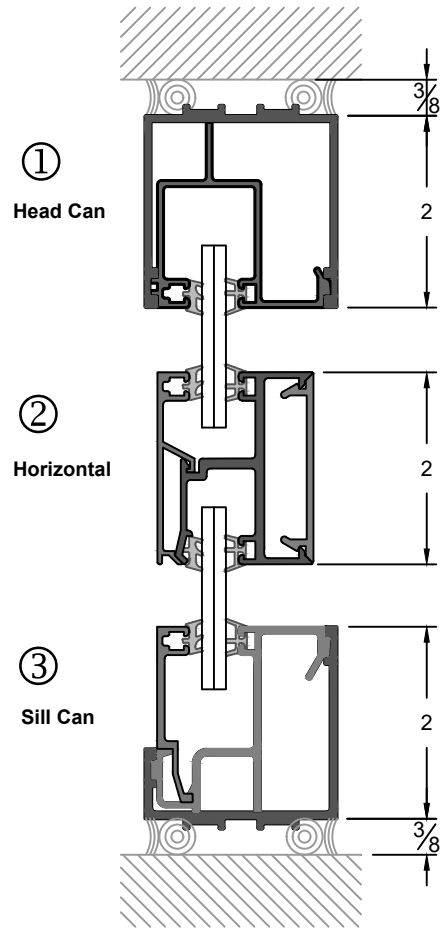
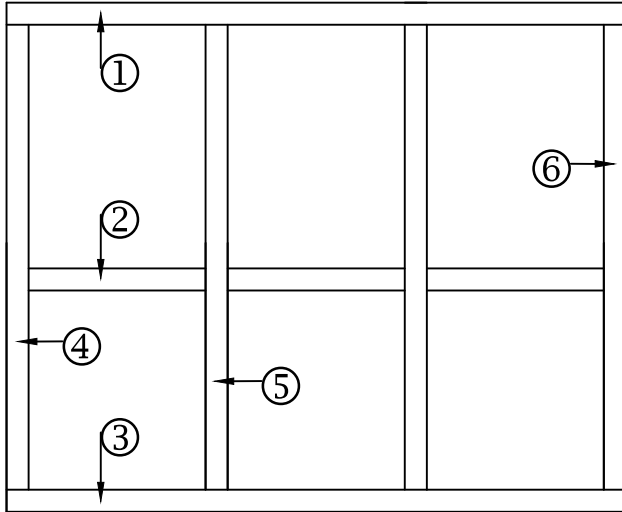
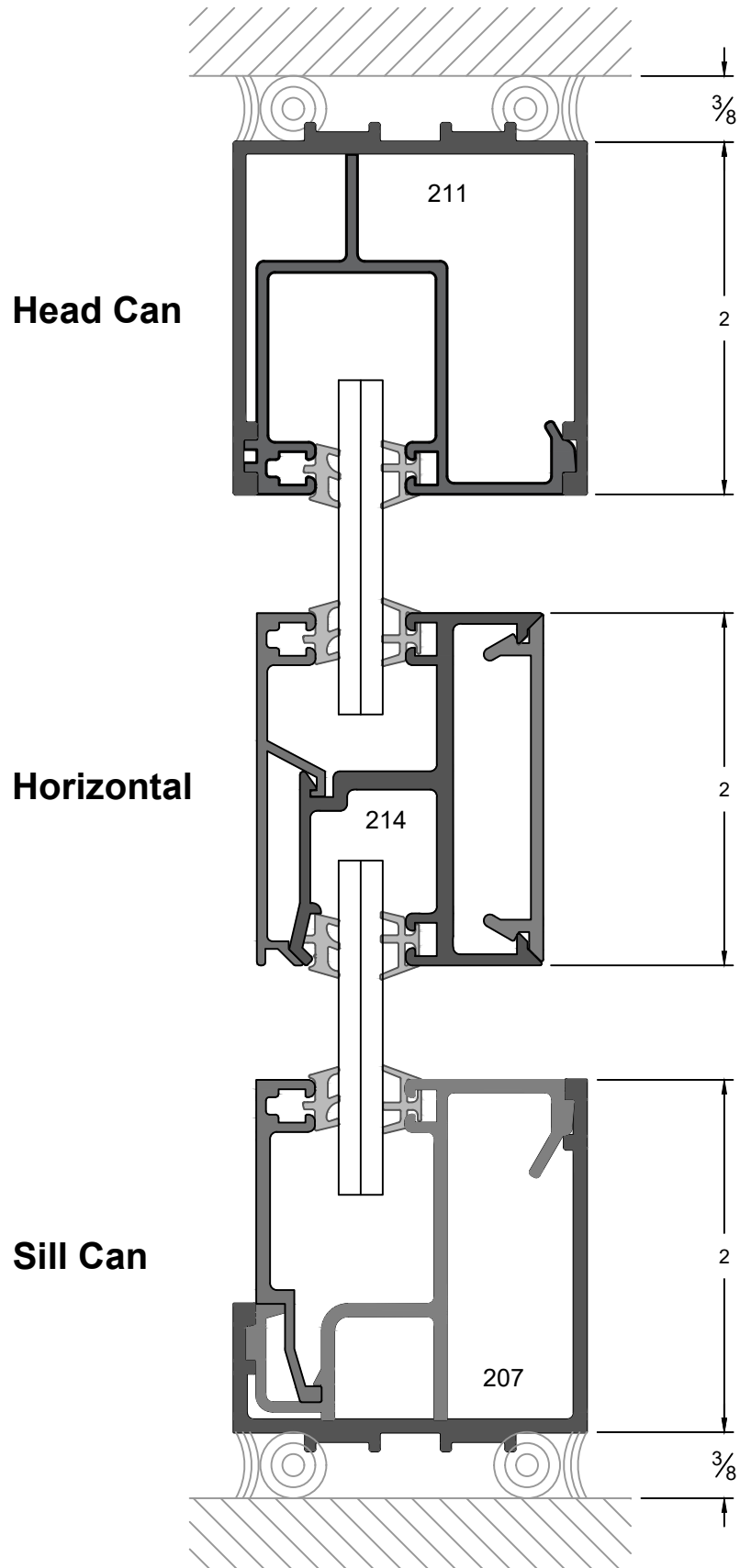
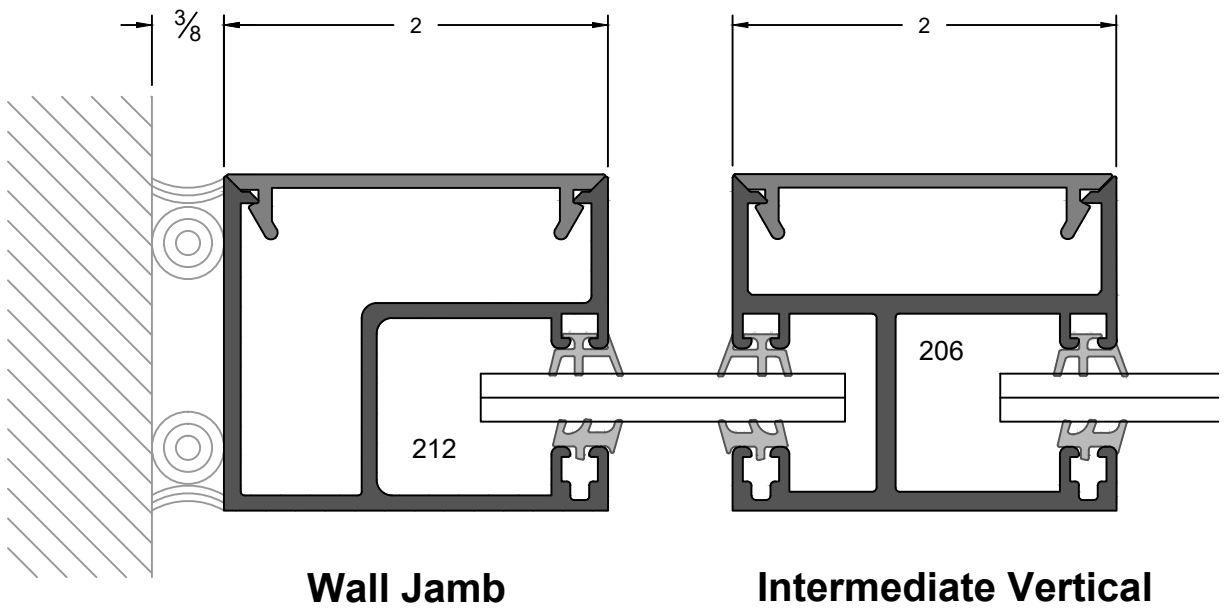

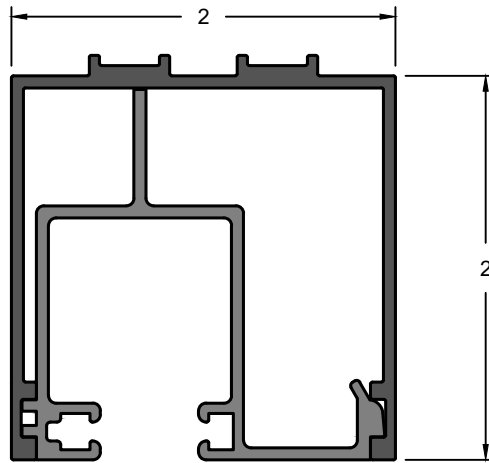

**Head Can Assembly**

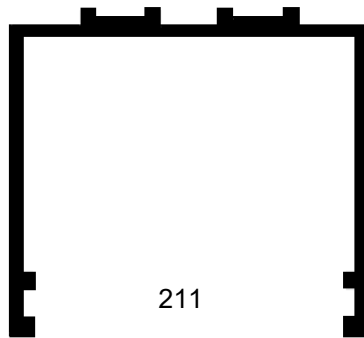

**Head Can**

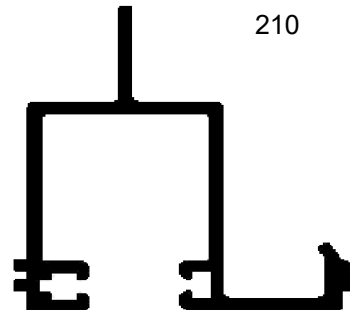

**Head Can Filler**

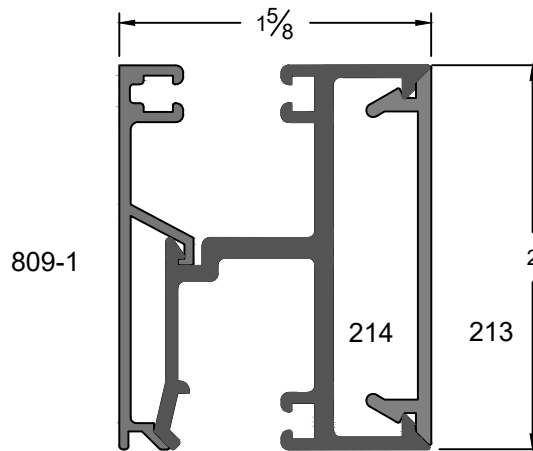

**Horizontal Assembly**

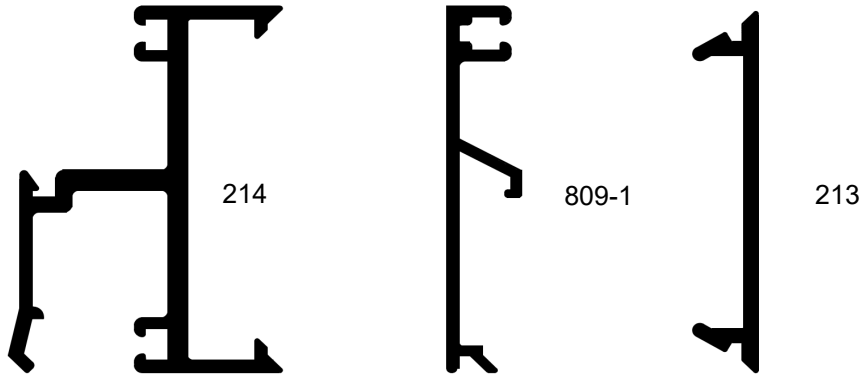

**Horizontal      Glass Stopper      Filler**

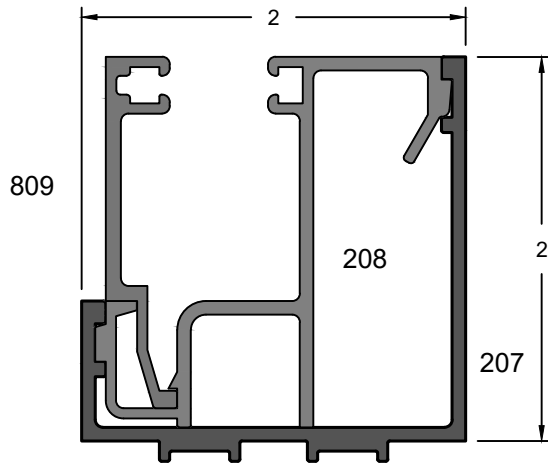

**Sill Can Assembly**

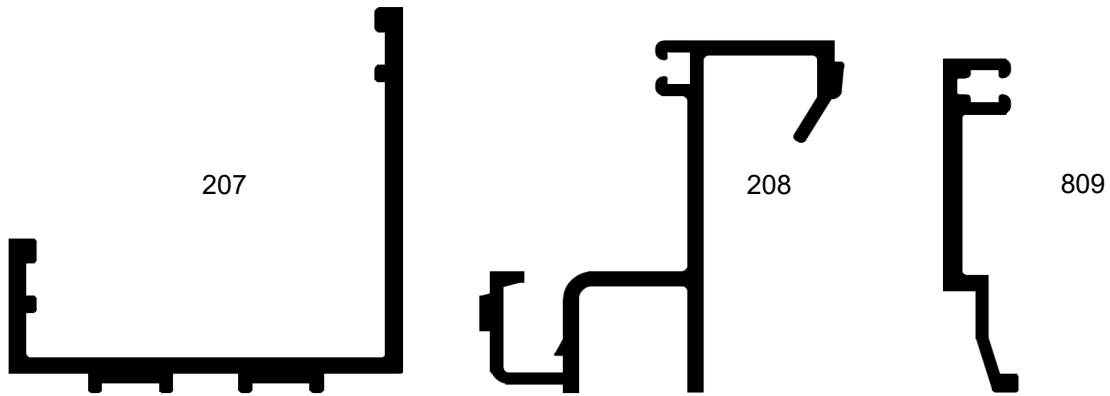

**Sill Can      Sill Can Insert      Glass Stopper**

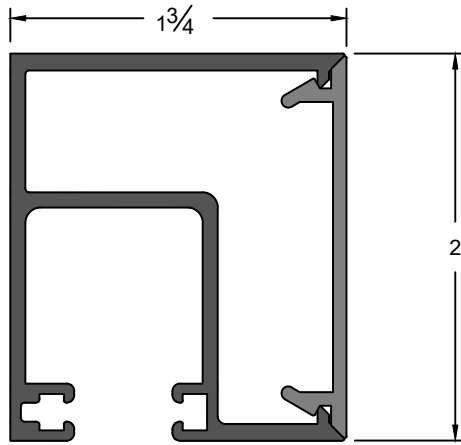

**Wall Jamb Assembly**

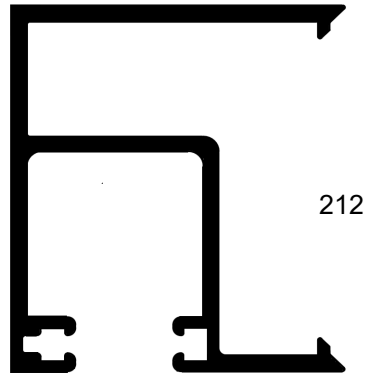

**Wall Jamb**



**Flat Filler**



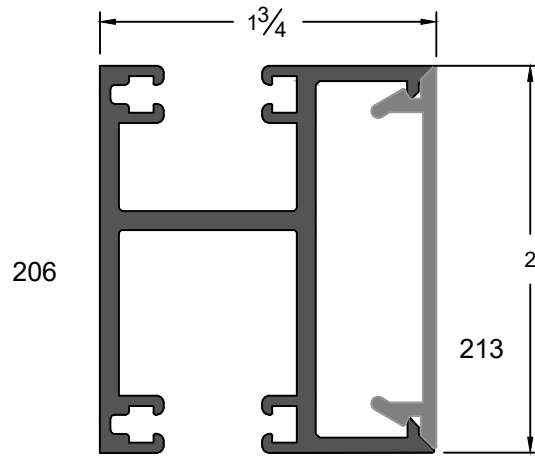

**Intermediate Vertical Assembly**

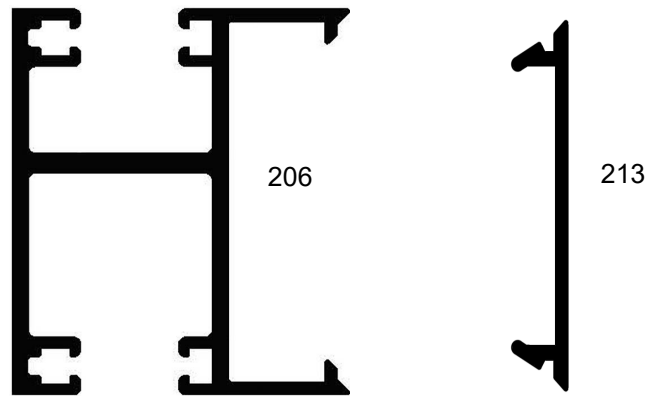

**Inter. Vertical**

**Flat Filler**

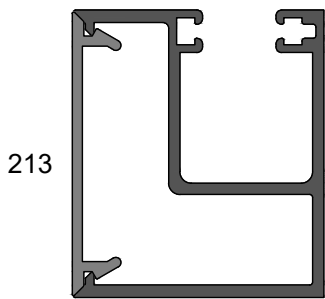
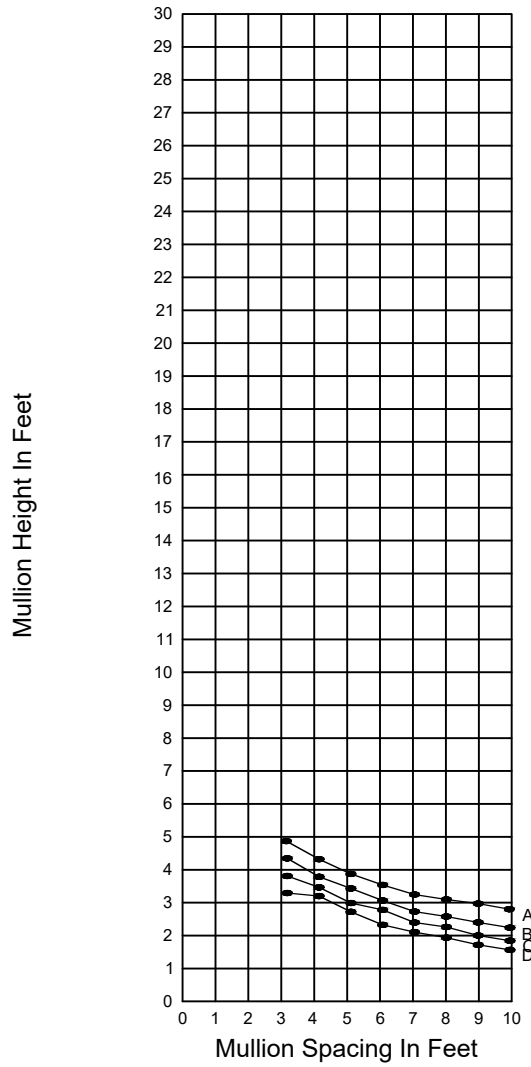

212

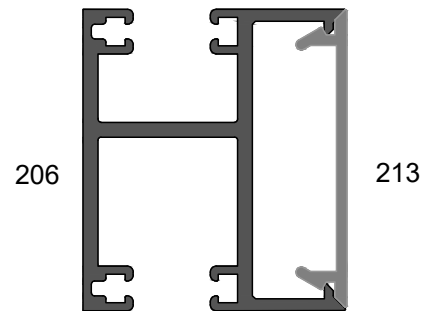

Curve Representation : A = 15 PSF  
 B = 20 PSF  
 C = 25 PSF  
 D = 30 PSF