





















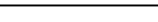

ITEM NUMBER	DRAWING	DESCRIPTION
511		Head Can
510		Head Can Filler
507		Sill Can
508		Sill Can Insert
509		Glass Stop
514		Horizontal
4-117		Horizontal Clip
113		Wall Jamb Filler
113-1		Wall Jamb Flat Filler
512		Wall Jamb
512S		Wall Jamb w/ Screw Raise
504		Vertical 1- Pocket
506		Intermediate Vertical 2- Pocket
503		Door Jamb
501		Door Header
102		Door Header Filler w. Mohair
102-1		Door Header Flat Filler

ITEM NUMBER	DRAWING	DESCRIPTION
5-401		Corner Post w/o Pocket
5-402		Corner Post w/ One Pocket
5-403		Corner Post w/ Two Pockets
113-2		1/4" Pocket Filler
4-115		Door Header Clip

500 SERIES

1 3/4" x 4 1/2" x 1/4" CENTER GLAZED SYSTEM

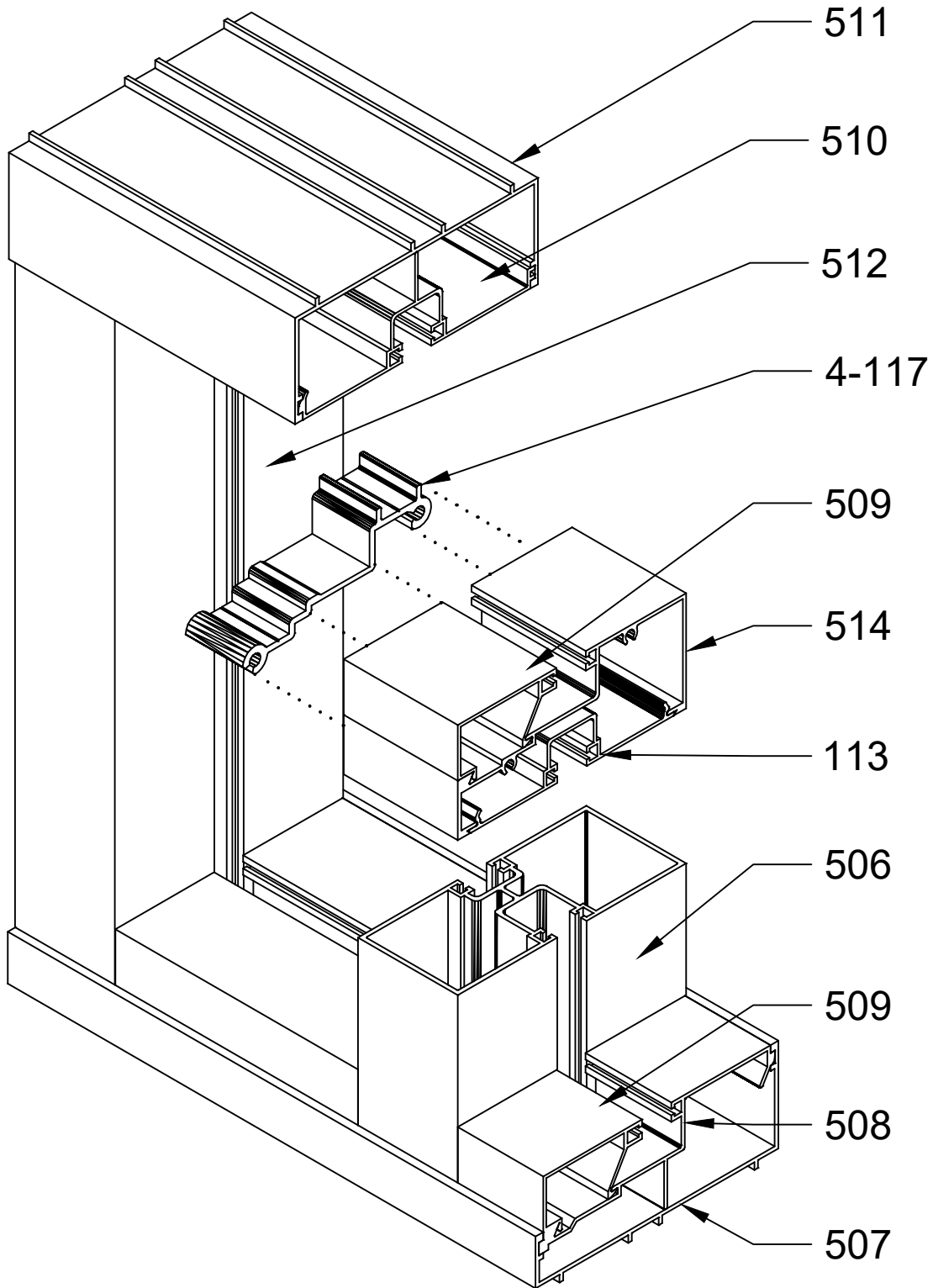

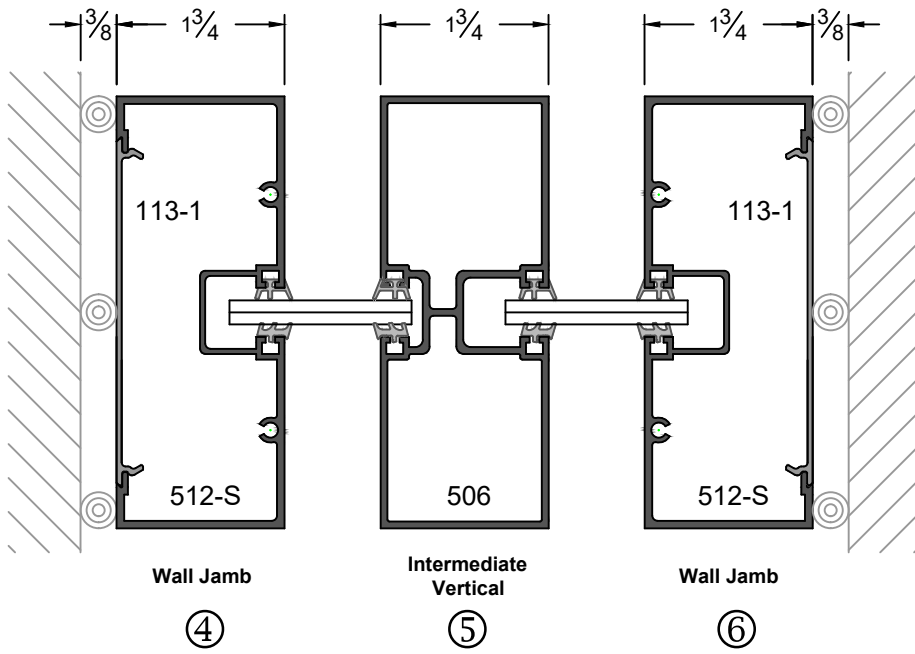
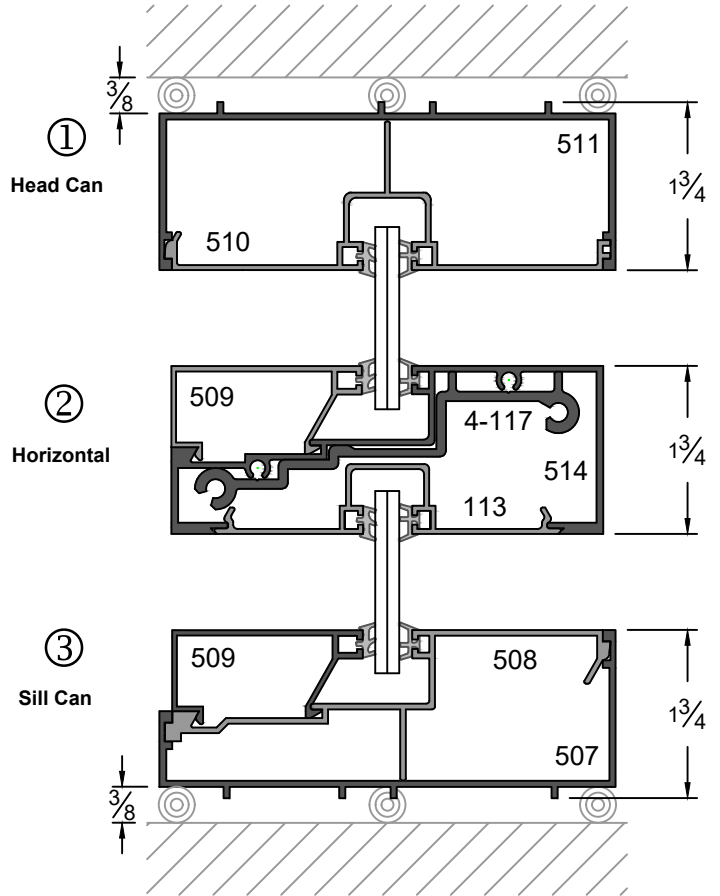
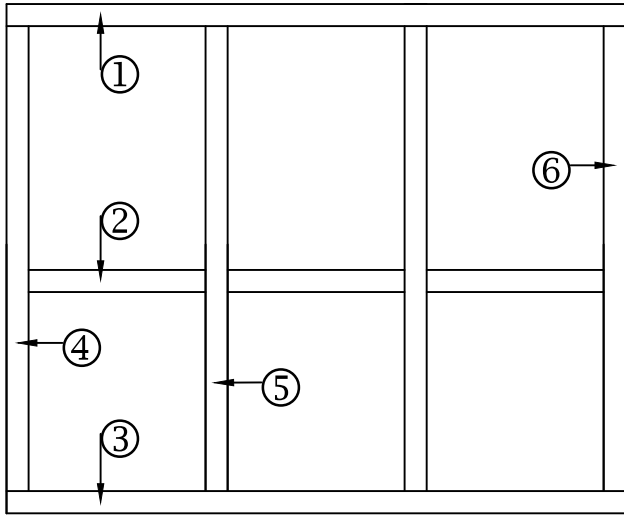

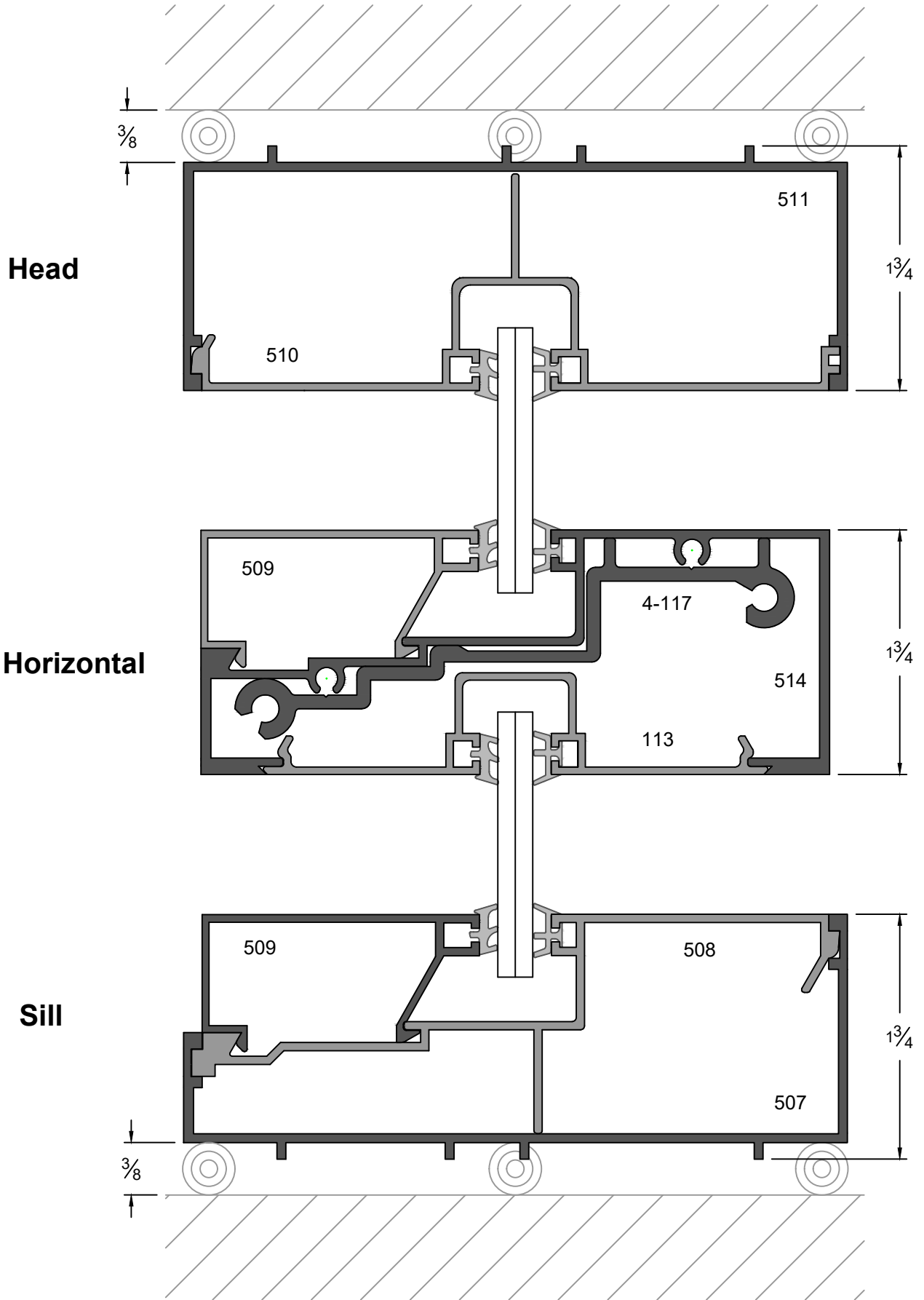

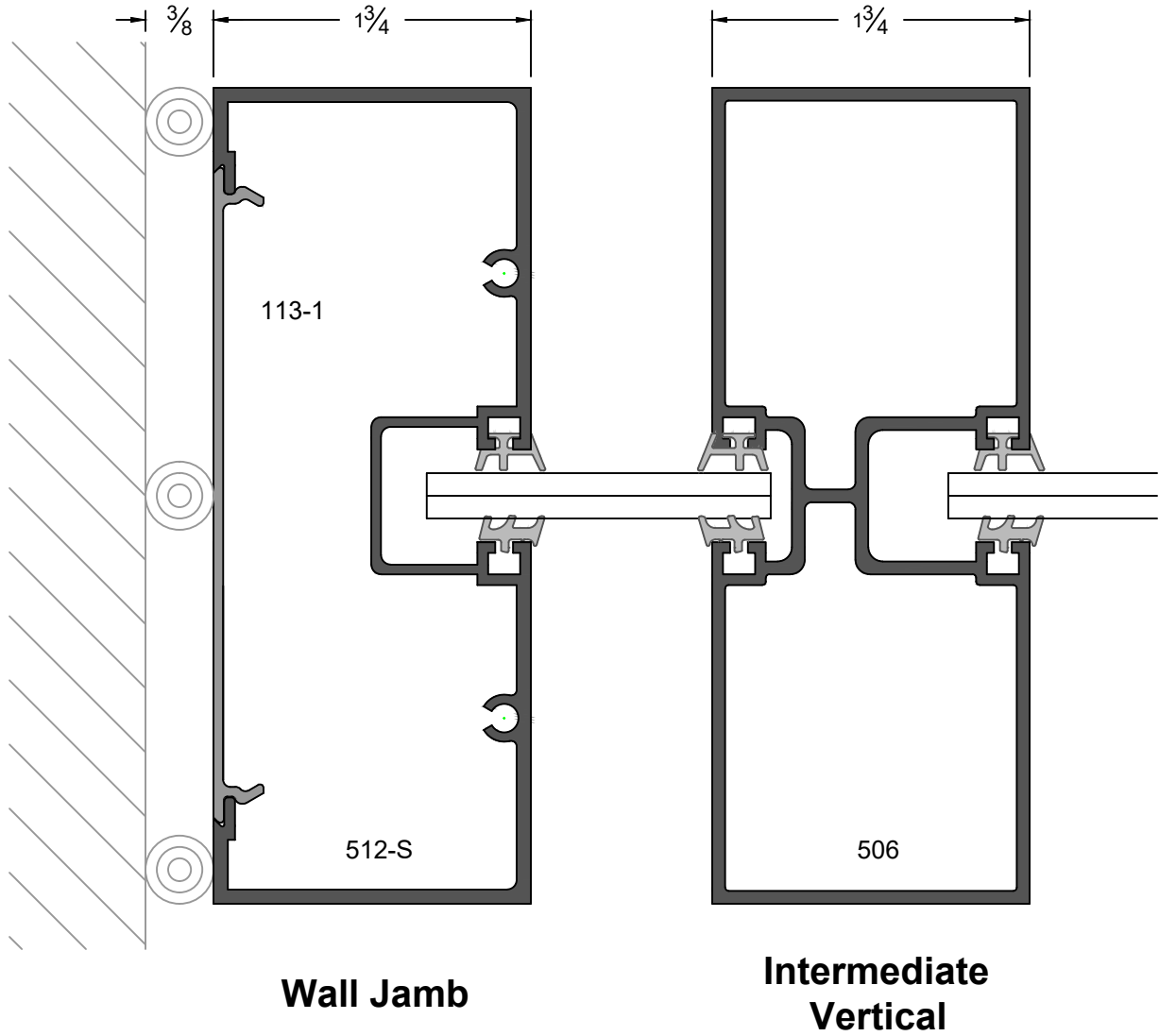

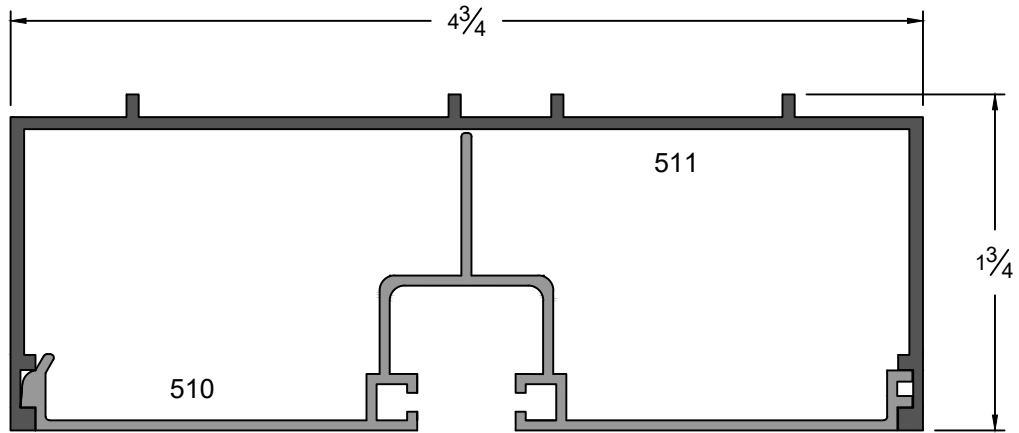

Head Can Assembly

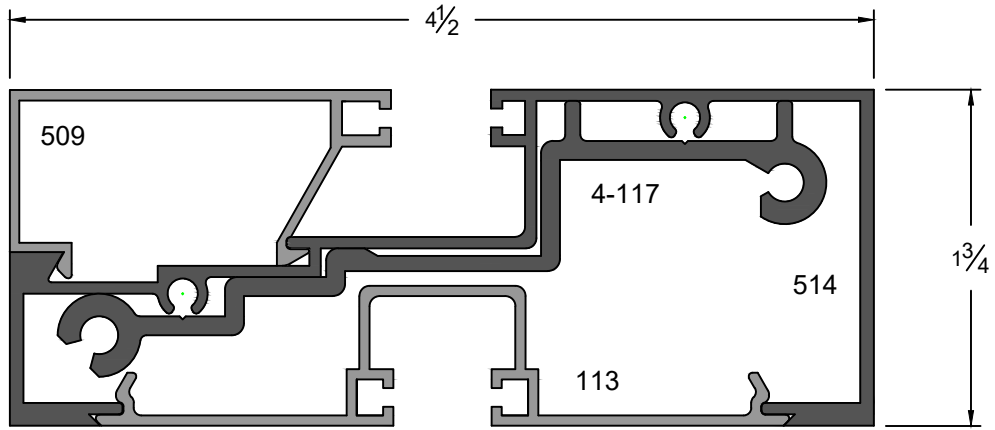

Horizontal Assembly

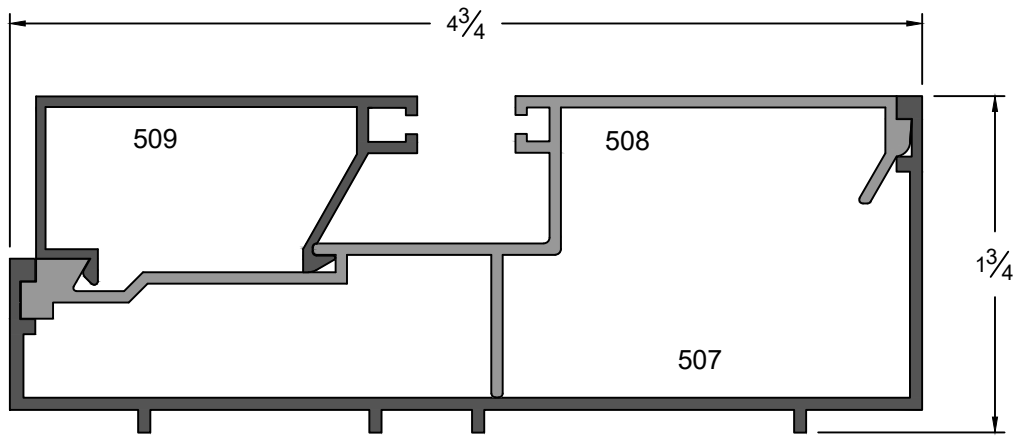

Sill Can Assembly

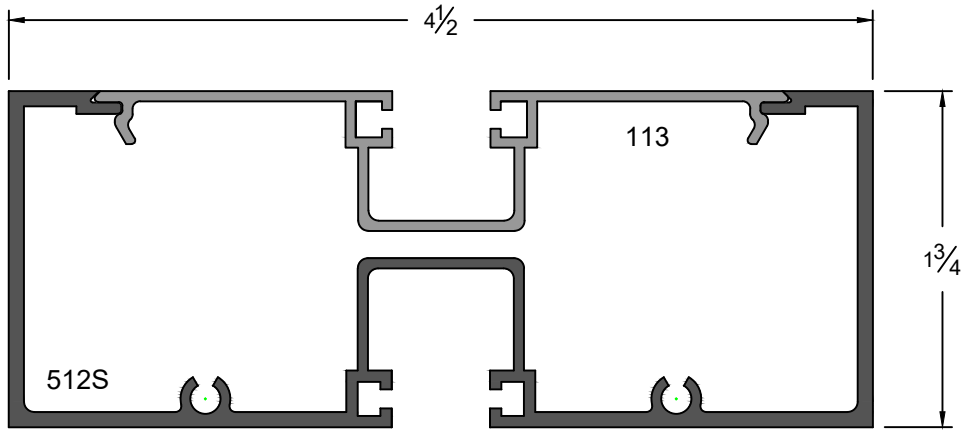

Wall Jamb Assembly

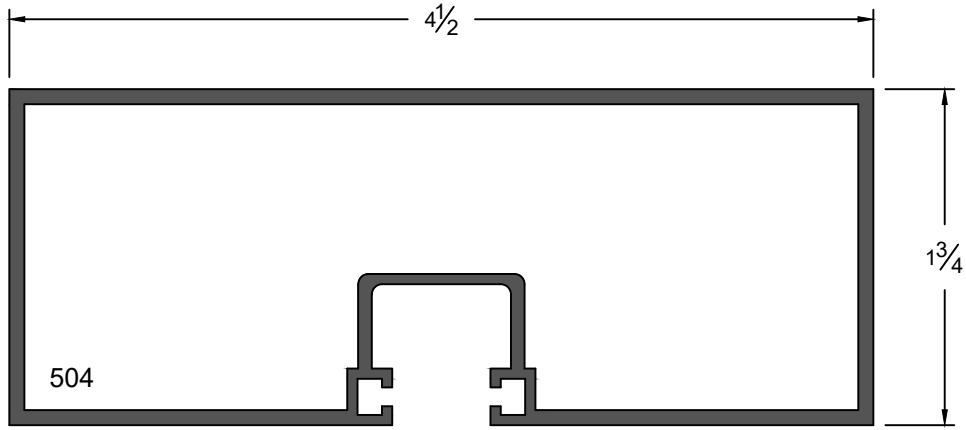

Vertical

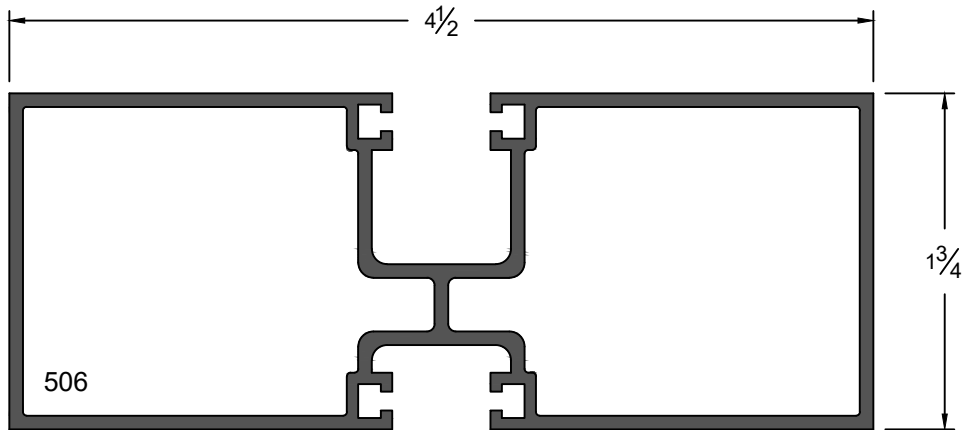

Intermediate Vertical

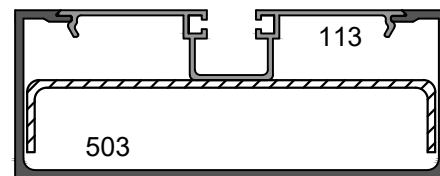
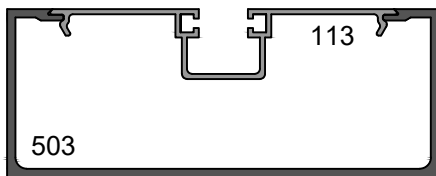
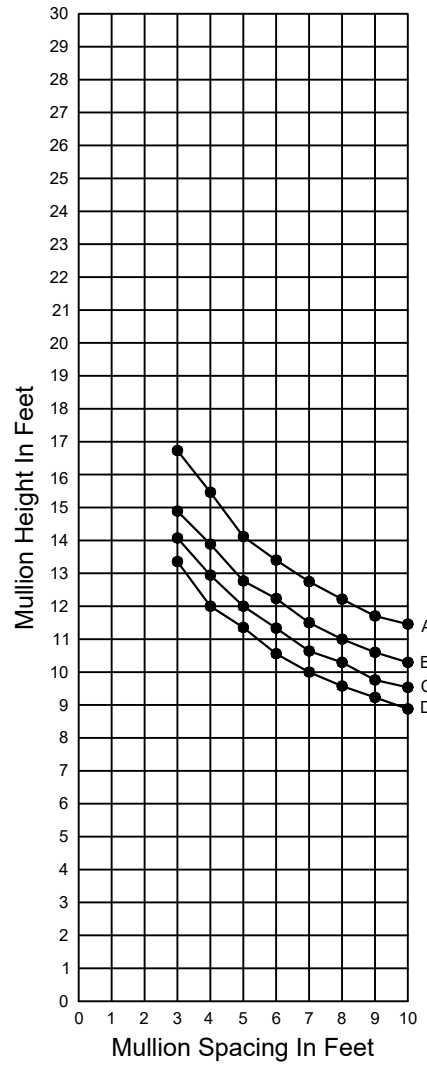
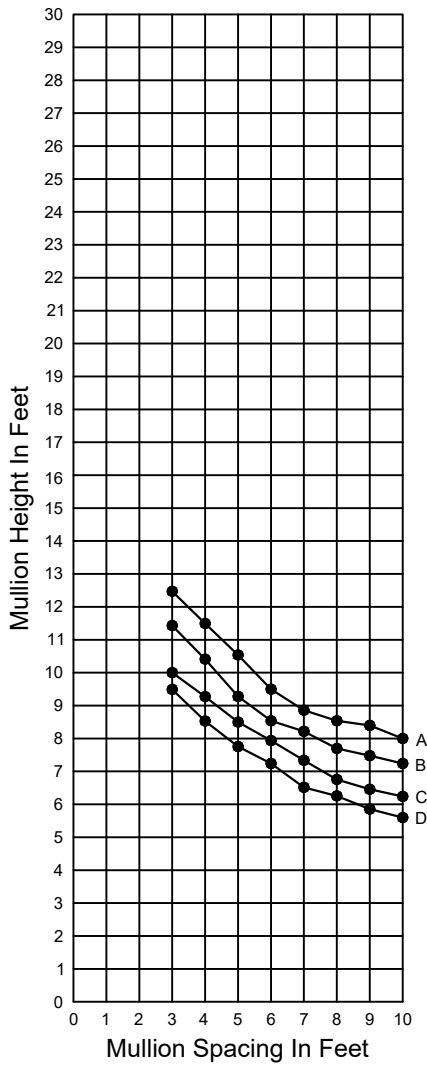

Curve Representation : A = 15 PSF
B = 20 PSF
C = 25 PSF
D = 30 PSF

With 12 GA. Steel Stiffener

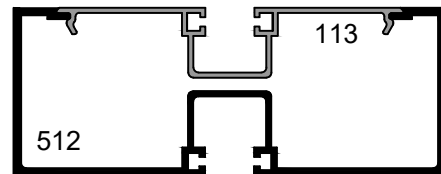
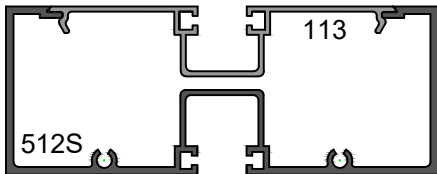
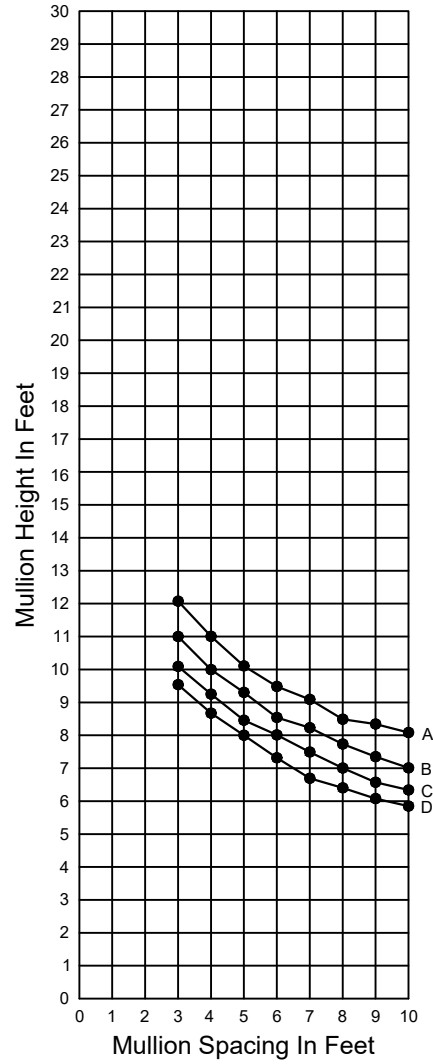
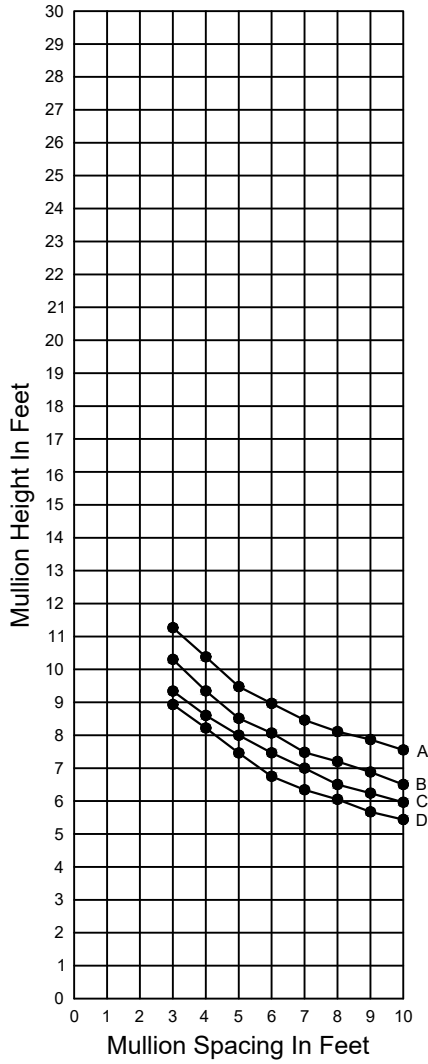

Curve Representation : A = 15 PSF
 B = 20 PSF
 C = 25 PSF
 D = 30 PSF

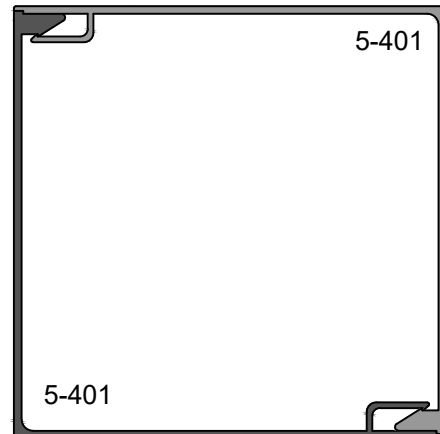
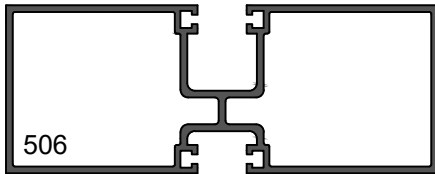
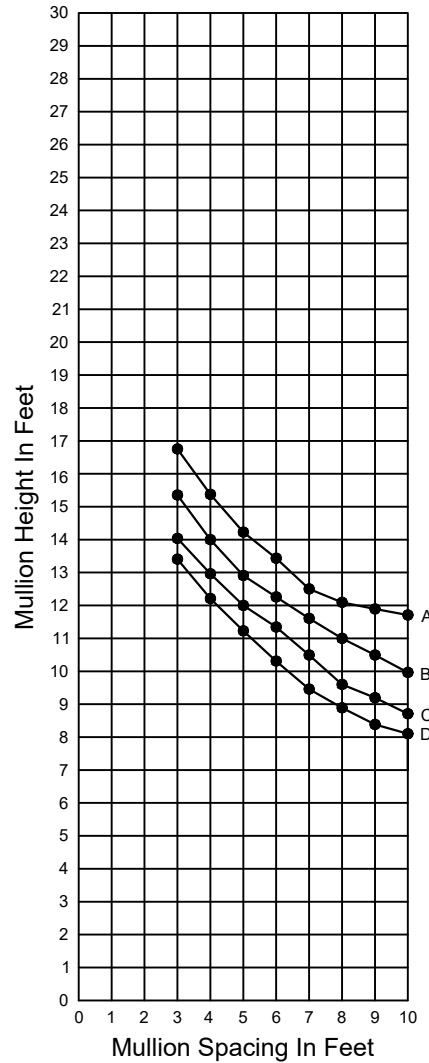
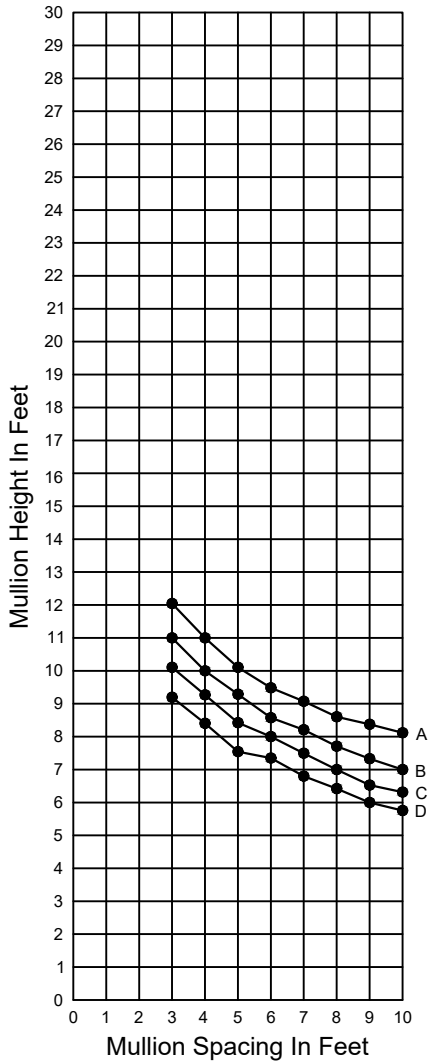

Curve Representation : A = 15 PSF
 B = 20 PSF
 C = 25 PSF
 D = 30 PSF

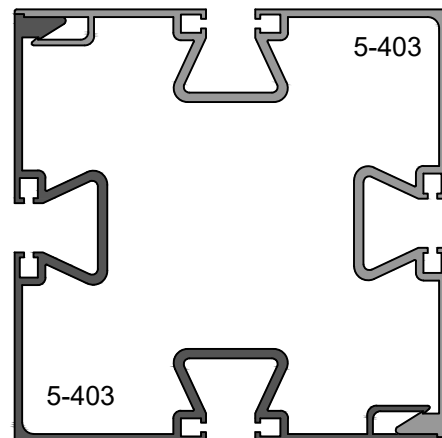
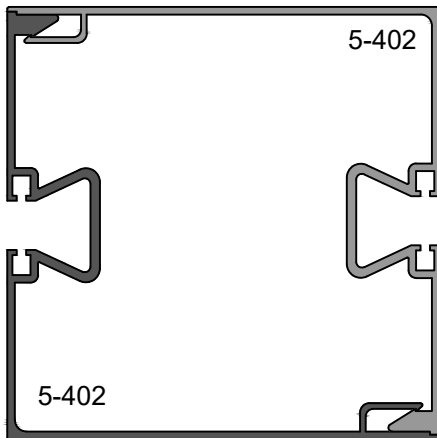
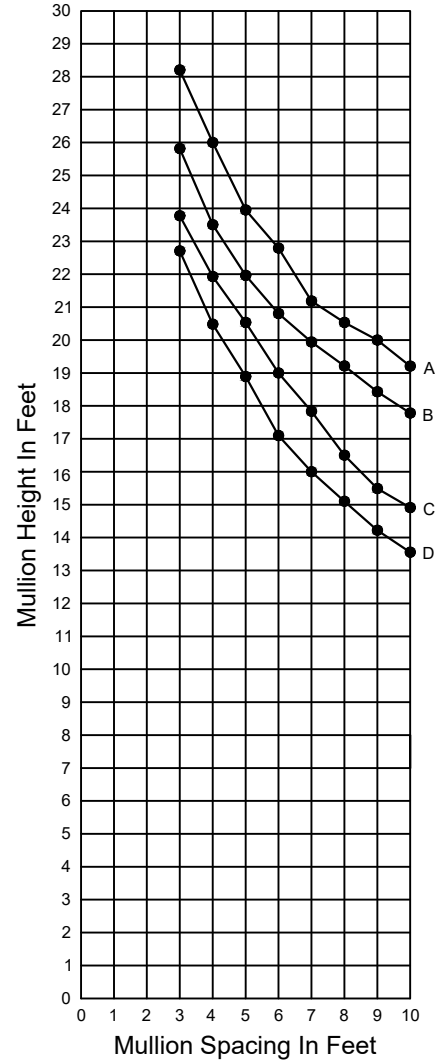
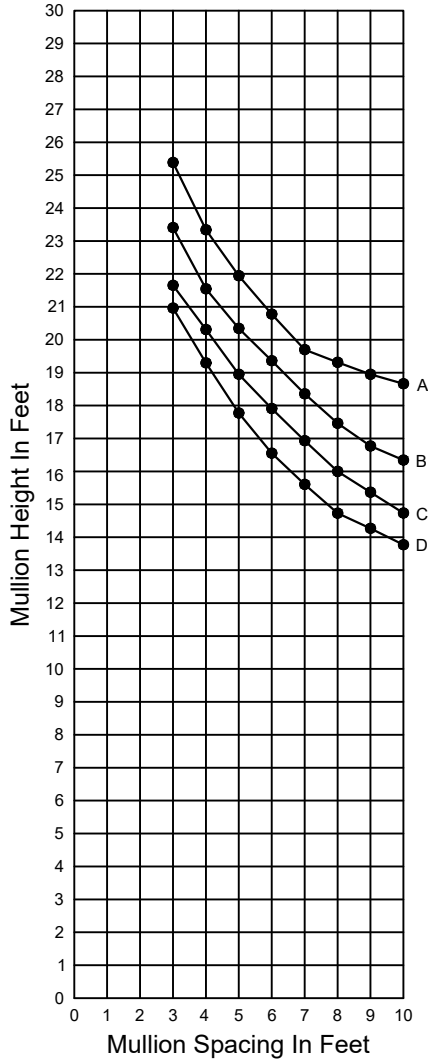

Curve Representation : A = 15 PSF
 B = 20 PSF
 C = 25 PSF
 D = 30 PSF