

Index

Specification	234
Warranty	235
Profile	236
Cutsheet	238
Accessories	244
Wind Load	245
Dead Load	246

Glazed Entrances, Windows and Curtainwall products vary widely. Building codes, safety codes and laws, govern the design and use of these products.

Atlas Aluminum assumes no responsibility in the selection of glazed materials, operating hardware or product configurations. It is the responsibility of the owner, architect and installer to make the proper selection in accordance with all building, safety codes and applicable laws.

Atlas Aluminum reserves the right to make configuration changes deemed necessary for the improvement of their product with out prior notice.

Specifications

1. General Description

Work Included: Glazing Contractor to supply all necessary materials, labor and equipment for the complete installation of aluminum framing as show on the drawings and specifications.

Work Not Included: Structural support of the framing system, interior closures, trim (please specify other exclusions).

2. Quality Assurance

Drawing and specifications are based on Atlas Aluminum Series (C8000) Offset glazed system. When required, supporting technical literature, samples, drawings and performance data will be submitted. Test reports certified by an independent test laboratory are to be made available upon request.

3. Performance Requirements

Air Infiltration: shall be tested in accordance with ASTM E 283. Air infiltration shall not exceed .06 CFM per square foot (.0003m₃ / sm₂ of fixed area when tested at 15 P.S.F. (300 Pa).

Water Infiltration: shall be tested in accordance with ASTM E 331. No water penetration at test pressure of 15 P.S.F. (384 Pa).

Structural Performance: shall be tested in accordance with ASTM E 330 and based on:

- Maximum deflection of $\frac{1}{175}$ of the span
- Allowable stress with a safety factor of 1.65

The system shall perform to this criteria under a windload of (please specify) P.S.F.

4. Materials

Extrusions shall be 6063-T5 alloy and temper (ASTM B221 alloy T5 temper). Fasteners, where exposed, shall be aluminum, stainless steel or zinc plated steel in accordance with ASTM A 164. Perimeter anchors shall be aluminum or steel, providing the steel is properly isolated from the aluminum. Glazing gasket shall be E.P.D.M. elastometric extrusions.

5. Finish

All exposed framing surfaces shall be free of scratches and other serious blemishes. Aluminum extrusions shall be given a caustic etch followed by an anodic oxide treatment to obtain a Class 1 (7-mill. thick standard (Please specify from below).

- Clear anodic coating
- Dark Bronze anodic coating
- Black anodic coating
- Other (specify finish)

A Fluoropolymer paint coating conforming with the requirements of the AAMA 605.2-92.

6. Fabrication

The Framing system shall provide for flush glazing on all sides with no projecting stops. Vertical and horizontal framing members shall have a nominal face dimension of (Please specify). Overall depth shall be (please specify). Entrance framing members shall be compatible with glass framing in appearance. Provide for internal drainage of infiltrated water into an extruded aluminum subsil channel where it is drained to the exterior of the system.

7. Installation

All glass framing shall be set in correct locations as shown in the details and shall be level, square, plumb and in alignment with other work in accordance with the manufacturer's installation instructions and approved shop drawings. All Joints between framing and the building structure shall be sealed in order to secure a watertight installation.

8. Protection and Cleaning

After installation the General Contractor shall adequately protect exposed portions of aluminum surfaces from damage by grinding and polishing compounds, plaster, lime, acid, cement, or other contaminants, and all work by other trades. The General Contractor shall be responsible for final cleaning.

Limited Warranty and Remedy

Atlas Aluminum warrants to its customers and all subsequent purchasers, that its products shall be free from defects in materials for a period of two year from shipment provided they are installed and maintained according to Atlas Aluminum instructions.

This warranty shall not include items, such as hardware, purchased by Atlas or others from outside hardware suppliers or manufacturers. Such warranties should be requested and obtained directly from hardware suppliers.













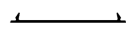

Atlas Aluminum warrants for a period of five (5) years from date of shipment that all exposed anodized aluminum furnished by Atlas Aluminum and specified to be processed to Aluminum Association Standards (AAMA12C22A31, A34, A41 or A44) shall conform to the following provided it is installed in and exposed to normal atmospheric conditions.

The sole and exclusive remedy with respect to the above warranty or with respect to any other claim relating to defects or any other condition or use of the products supplied by Atlas Aluminum, however caused, and whether such a claim is based upon warranty, contract negligence, strict liability or any other theory, is limited to repair or supply of such products or repayments by Atlas Aluminum of the purchase price paid to it at Atlas Aluminum's own option.

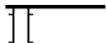
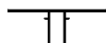
Atlas Aluminum does not make any other representations or warranties expressed or implied, including, but not limited to, any implied warranty of merchantability and any implied warranty of fitness for a particular purpose, in no event shall Atlas Aluminum be liable for special, direct, indirect or consequential damage, including but not limited to loss of use or profits.







CURTAIN WALL

C8000 Series 2 1/2" x 6"

ITEM NUMBER	DRAWING	DESCRIPTION
C8003		2 1/2" x 6" Open Back Vertical
C8000		2 1/2" x 6" Vertical
C8009		2 1/2" x 6" Silicone Vertical
C8013		Beauty Cap
C8012		Pressure Bar
C8011		L Pressure Bar
C8008		1/2" Pocket Reducer
C8006 (2813)		2 1/2" x 6" Flat Filler
C8007		Pocket Filler
C8904		Splice Sleeves 2 1/2" x 6"
C8937F		Vertical "F" Anchor
C8907T		Vertical "T" Anchor
C8903		Top Closer Plate (T/B)
C8909		Shear Blocks for 2 1/2" x 6"
C8908		Water Deflectors (AHD 975) (50@/PK)
C8097		Temporary Glass Stop (ACW 368 50@/pic)
C8901		Pressure Bar Screws (200@/PK)

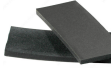
CURTAIN WALL

C8000 Series 2 1/2" x 6"

ITEM NUMBER	DRAWING	DESCRIPTION
C8097-1		Setting Block 3/8" x 1 1/8" x 4" (ASB 92)
C8097-2		Setting Block 1/4" x 1 1/8" x 4" (ASB 92)
C8097-3		Setting Block 1/2" x 1 1/8" x 4" (ASB 94)
VINCSF		Front Sponge EPDM Gasket
VINCEB		Back EPDM Gasket
VINPB		Pressure Bar Spacer Vinyl
VINSMG		Silicone Mullion Gasket

CURTAIN WALL

C8000 Series 2 1/2" x 6"

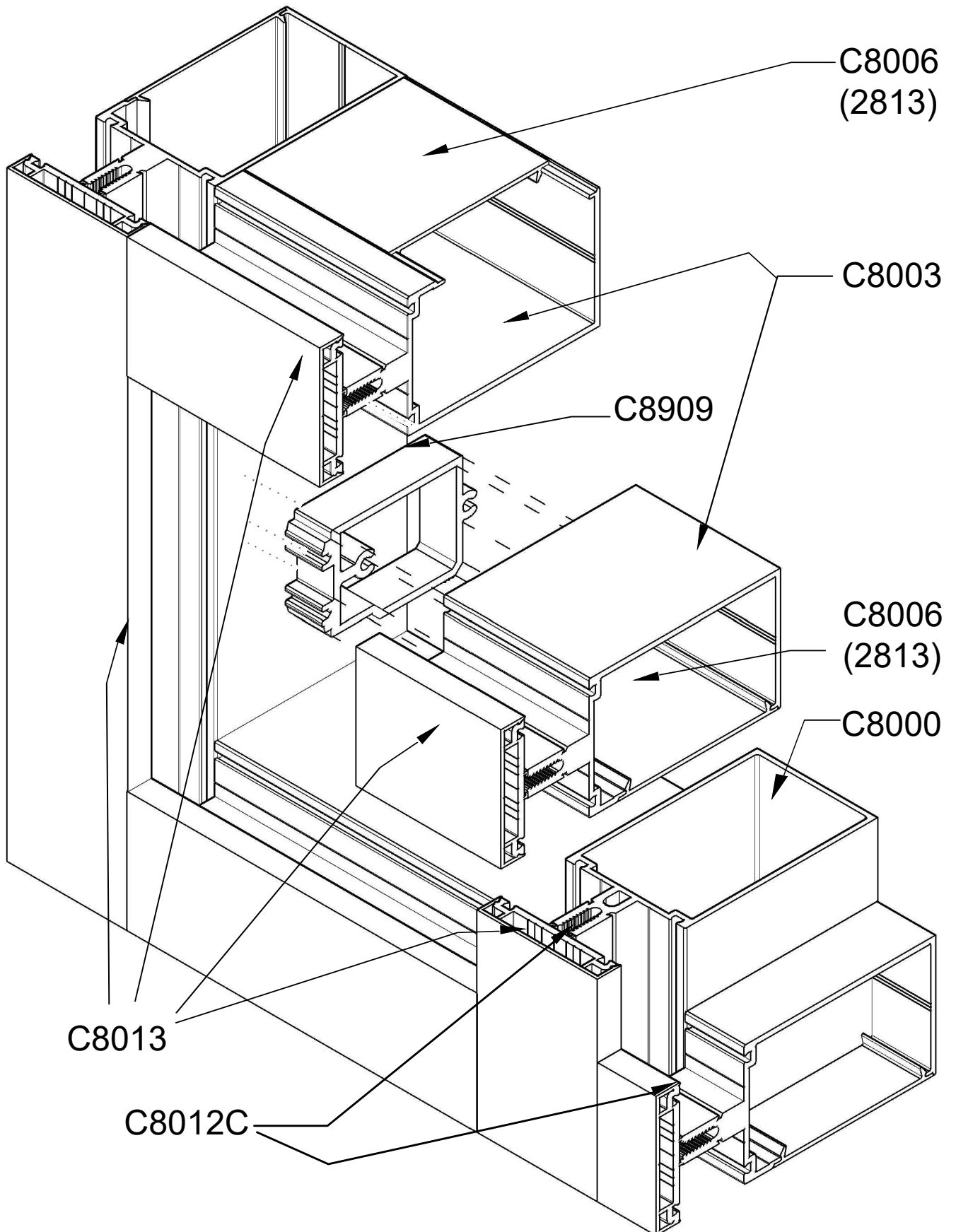

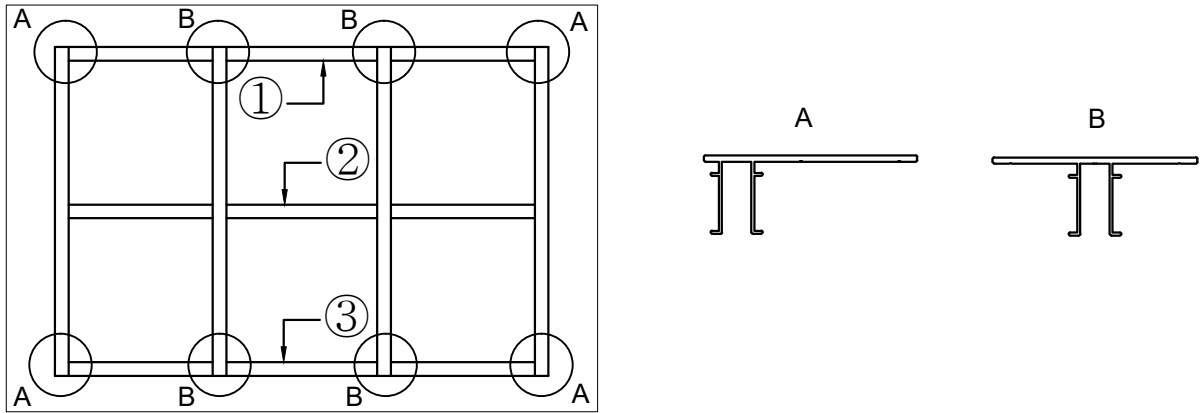

Typical Framing

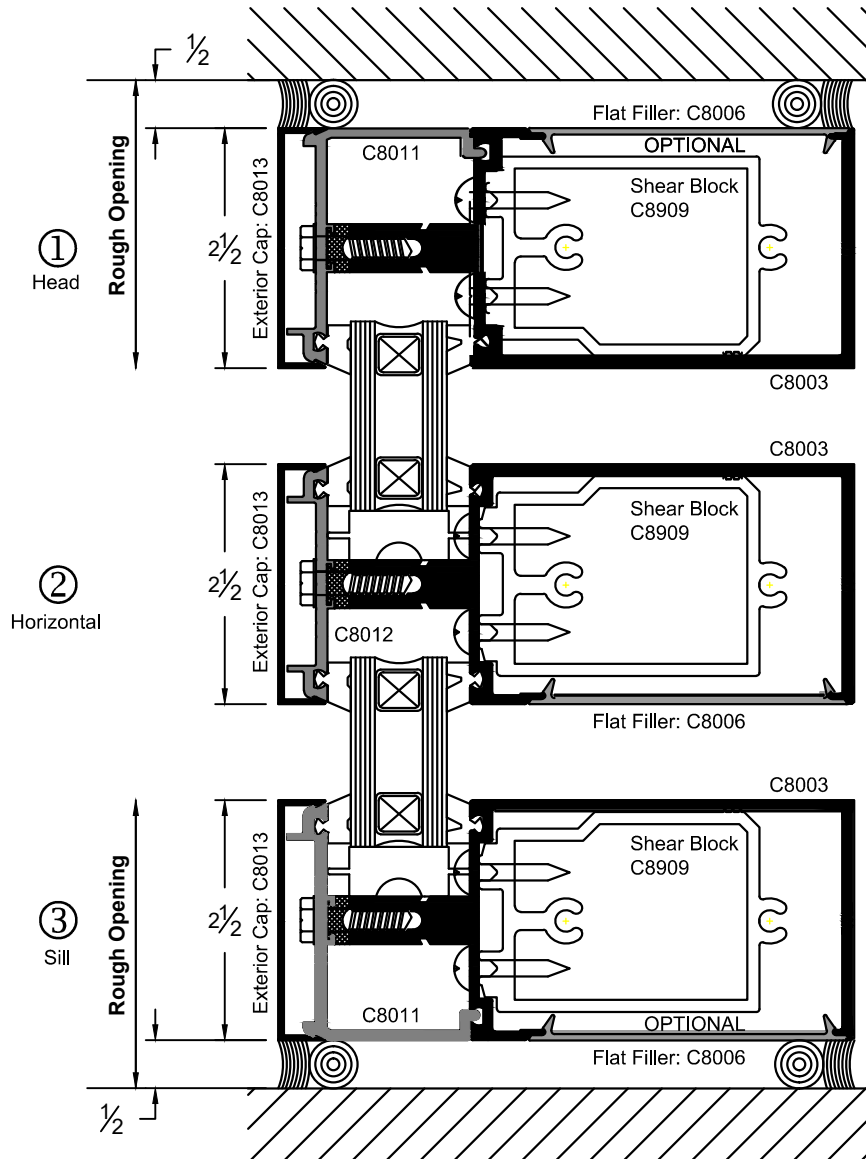

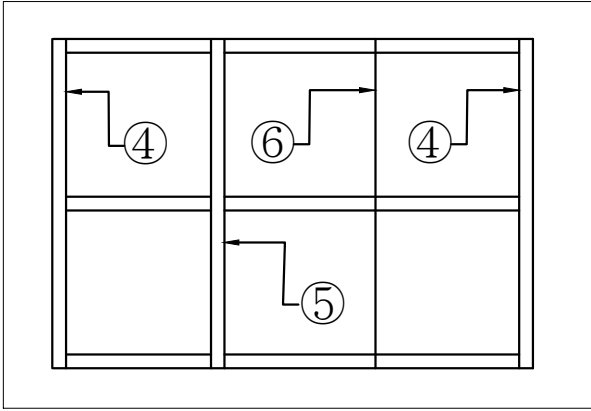

Typical Framing

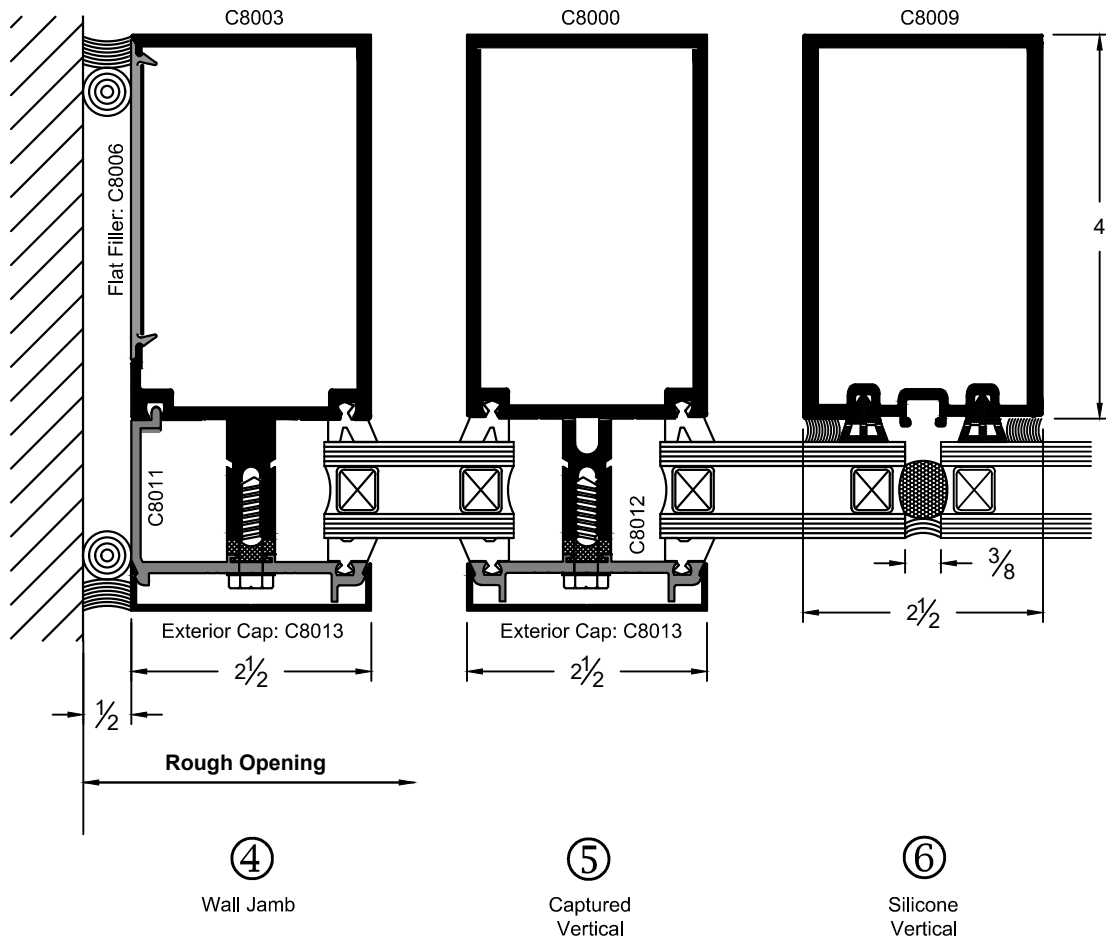

CURTAIN WALL

C8000 Series 2 1/2" x 6"

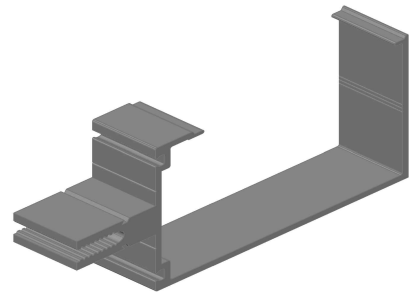
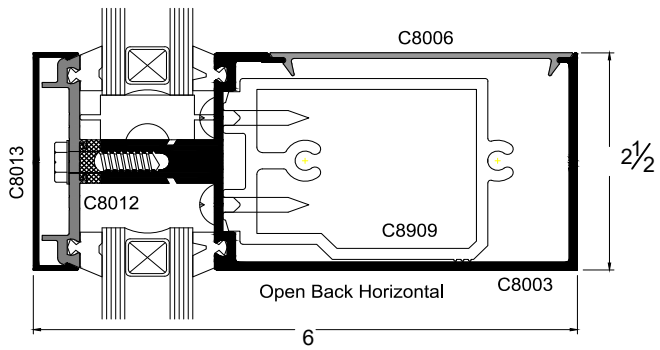
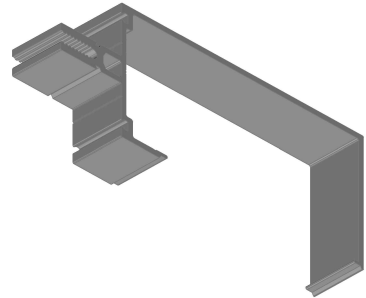
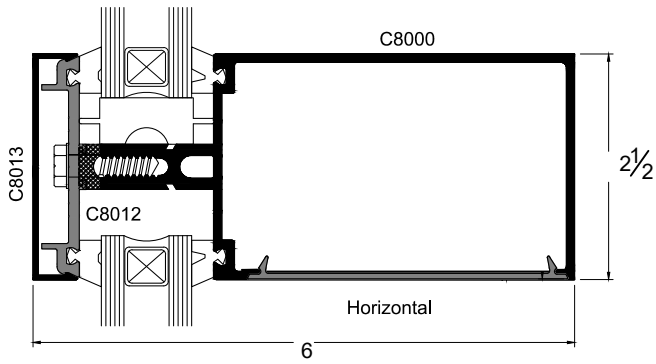
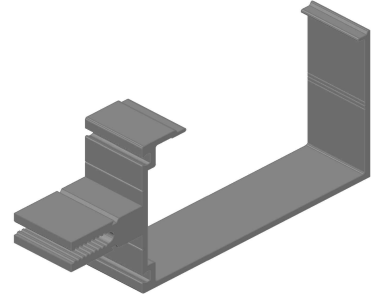
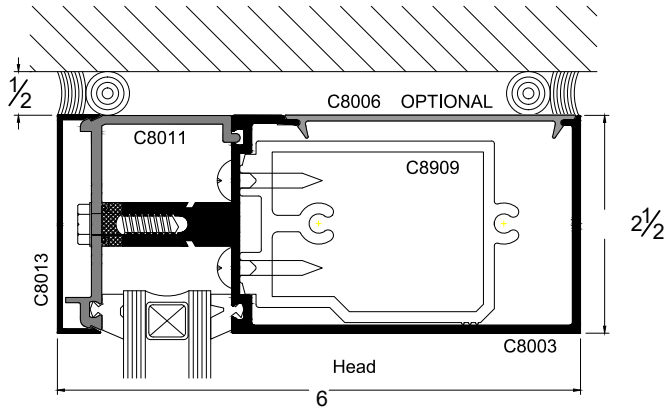

CURTAIN WALL

C8000 Series 2 1/2" x 6"

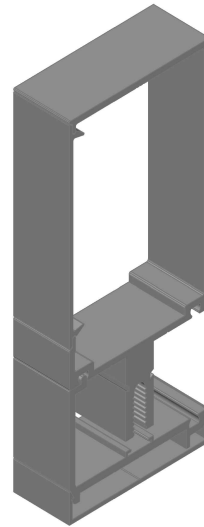
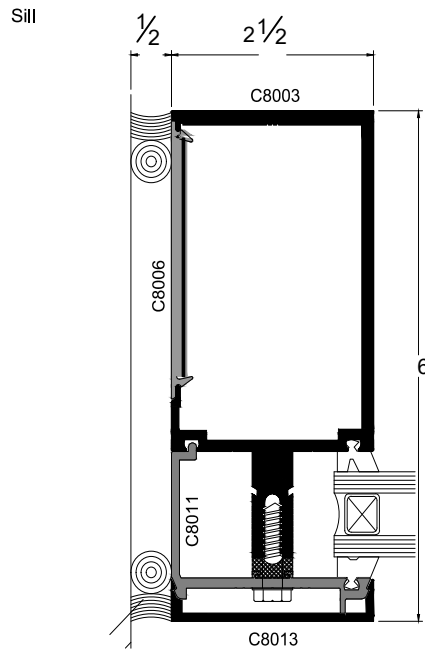
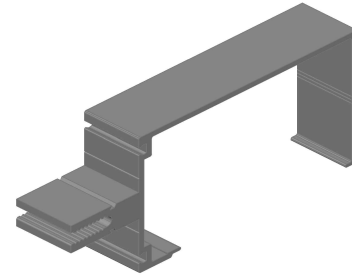
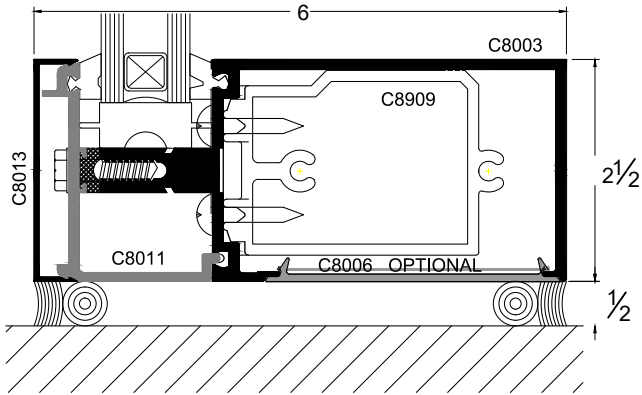

Wall Jamb

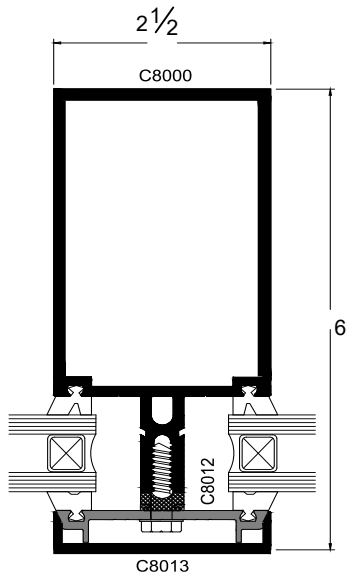

Captured Vertical

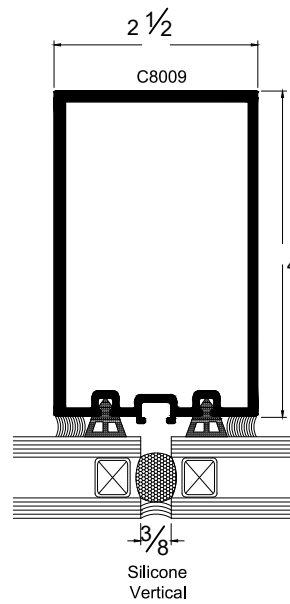
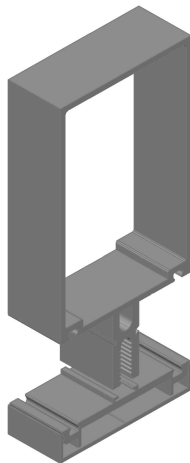

Silicone Vertical

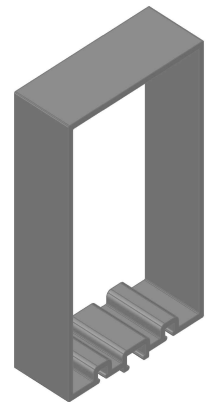

CURTAIN WALL

C8000 Series 2 1/2" x 6"

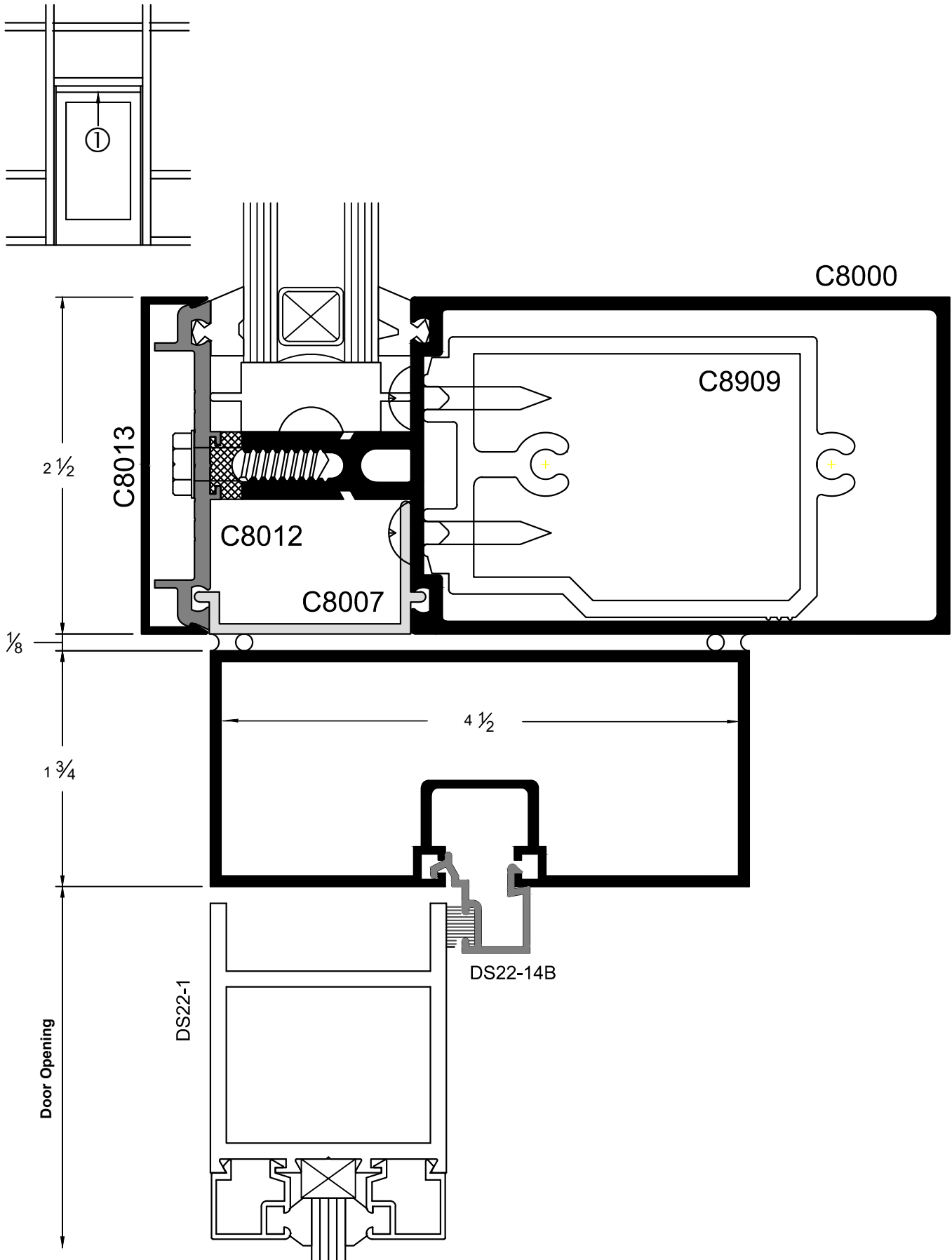

Accessories

Pressure Bar Spacer



VINPB

Splice Sleeves

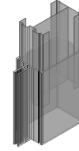

C8904 For C8000 Wall Jamb

Silicone Mullion Gasket



VINSMG

Gaskets



VINCSF



VINCEB

Shear Blocks

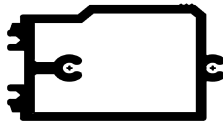

C8909 For C8000 & C8003

Water Deflectors

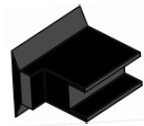

C8908

Screw For Pressure Bar

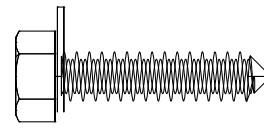

C8901

Top & Bottom Anchors

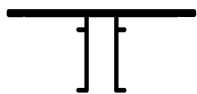

C8907T



C8937F

Top & Bottom Closure Plate

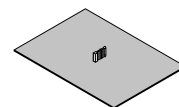

C8903

Wind Load Charts

Mullions are designed for deflection limitations in accordance with AAMA TIR-A11 of $L/175$ up to 13'-6" and $L/240 + 1/4"$ above 13'-6". These curves are for mullions with horizontals and are based on precise engineering calculations for stress and deflection. Allowable windload stress for 6063-T5 ALUMINUM 12,500 P.S.I. STEEL 26,700 P.S.I. Charted curves, in all cases are for the limiting value. For special situations not covered here, contact your Atlas Aluminum representative for additional information.

- A = 20 PSF
- B = 25 PSF
- C = 30 PSF
- D = 35 PSF
- E = 40 PSF

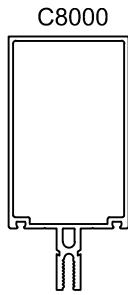

C8000
 $I_{xx} = 4.71$
 $S_{xx} = 1.58$

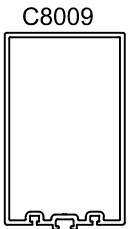
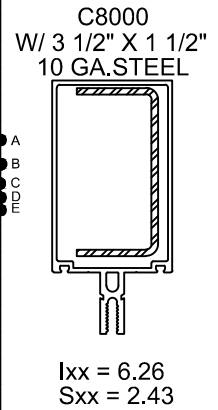
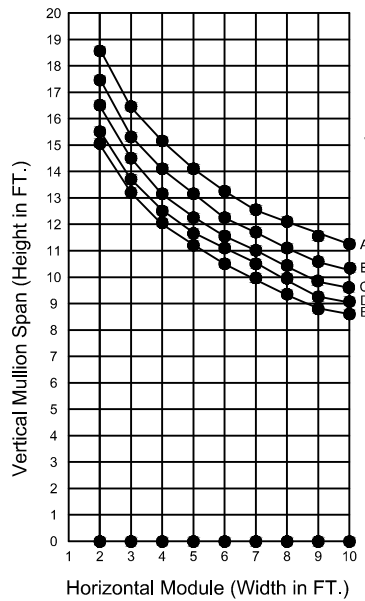
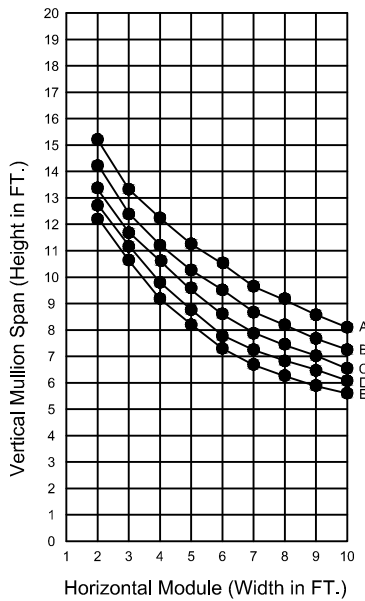

C8009
 $I_{xx} = 2.94$
 $S_{xx} = 1.37$

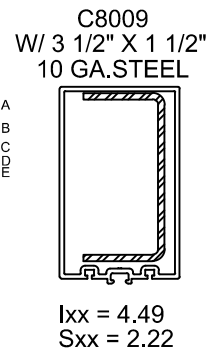
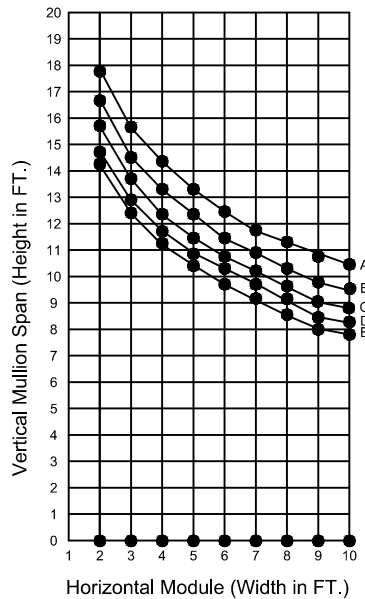
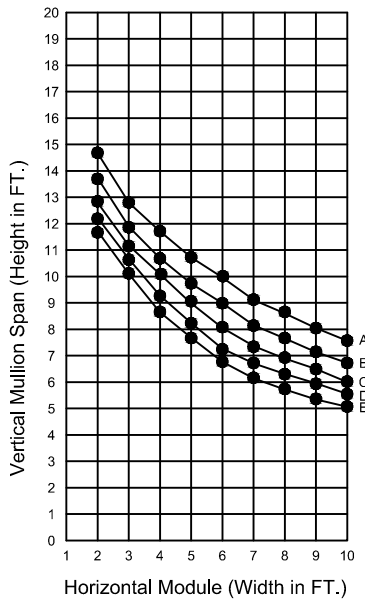

Dead Load Charts

Deadload charts are based on 1/8", *(1/16) maximum allowable deflection at the center point of the horizontal member and on the following glass weight 1/4" spandrel glass = 3.27 PSF. Glass shall rest on two setting blocks at: A= 1/4 points glass weight 1/4" spandrel glass = 3.27 PSF. Glass shall rest on two setting blocks at: A= 1/4 points, B = 1/8

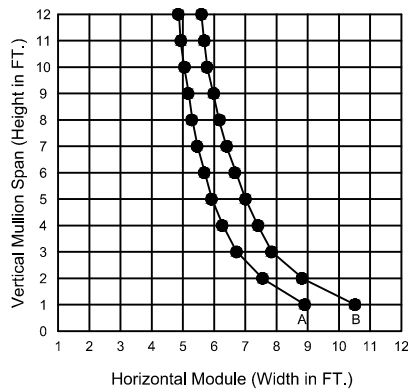

C8003
 I=.83