













ITEM NUMBER	DRAWING	DESCRIPTION
711		Head Can
710		Head Can Filler
707		Sill Can
708		Sill Can Insert
809		Sill Can Glass Stop
714		Horizontal
809-1		Horizontal Glass Stop
713		Horizontal Filler
113-1		Wall Jamb Flat Filler
712		Wall Jamb
704		Vertical
706		Intermediate Vertical
SS-60		2 1/2" x 1 1/2 " 10 ga. Steel Channel
4-119		Horizontal Clip
7-401		90° Corner Post (Offset)
7-402		90° Corner Post (Offset)
7-403		90° Corner Post (Offset)

**700 SERIES**

**2" x 4 1/2" x 1/4" OFFSET GLAZED SYSTEM**



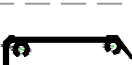
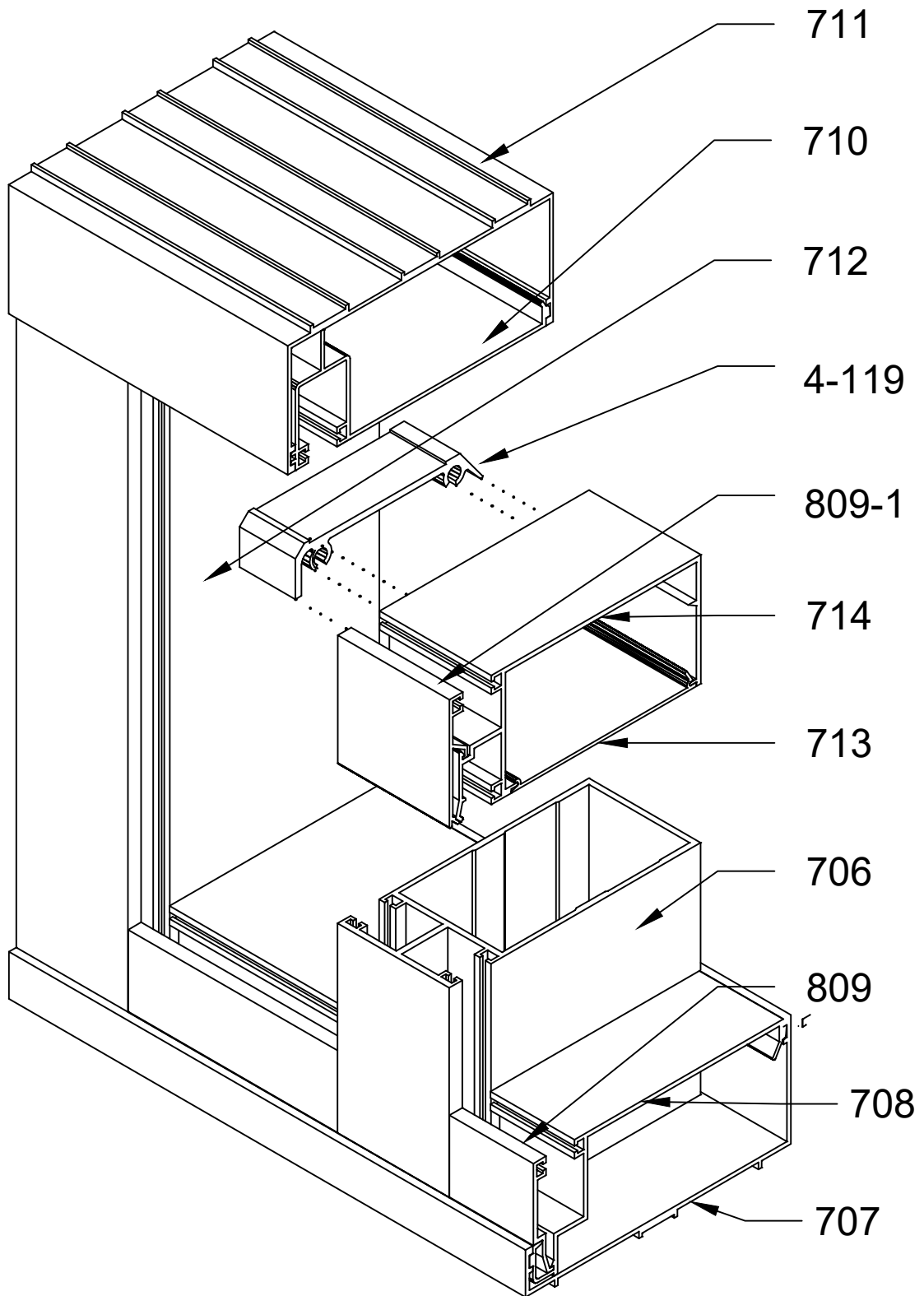
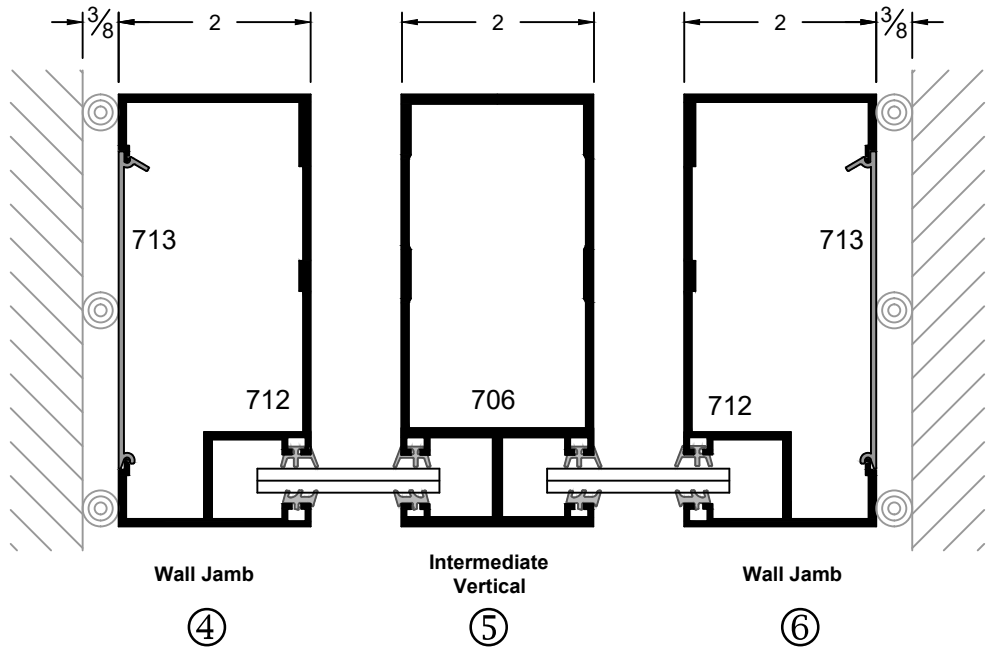
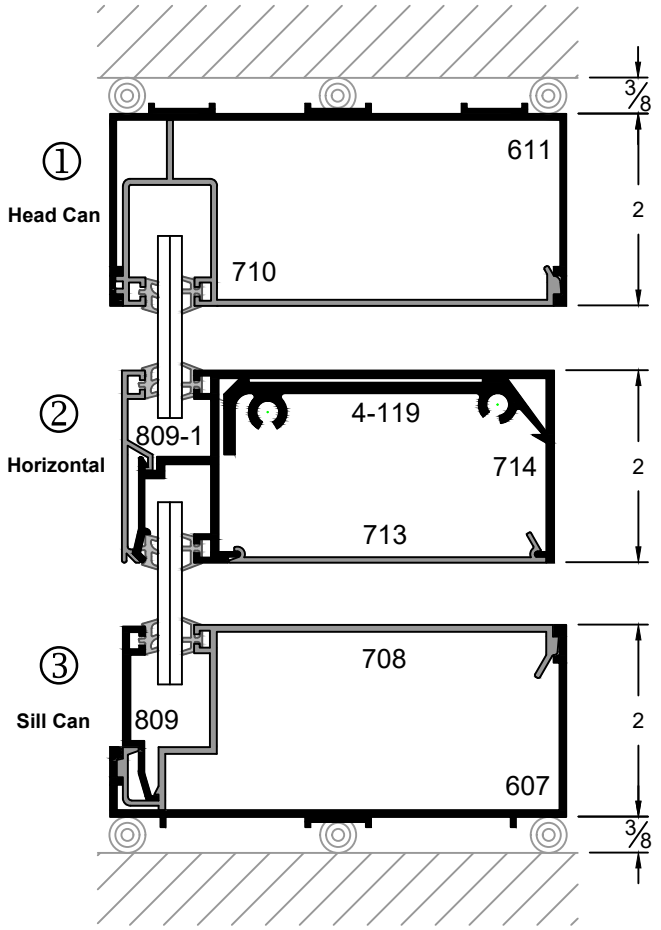
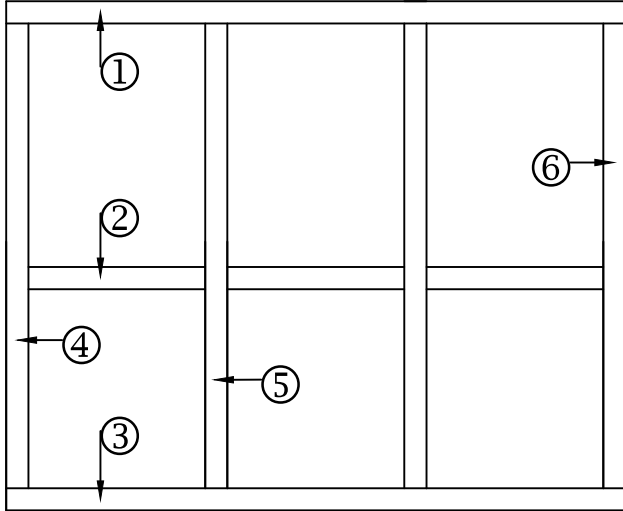

**Head Can**

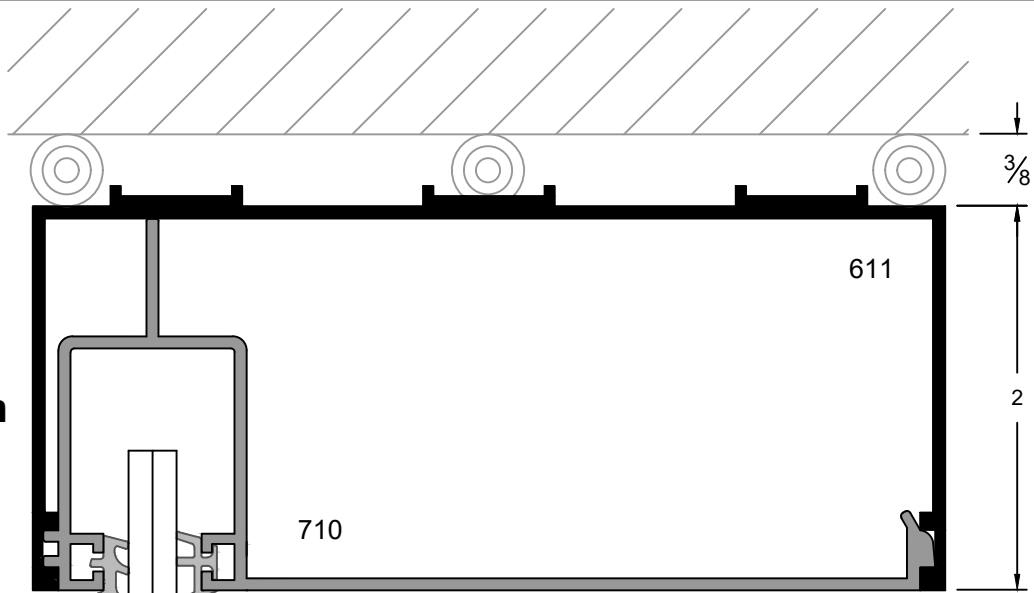

**Horizontal**

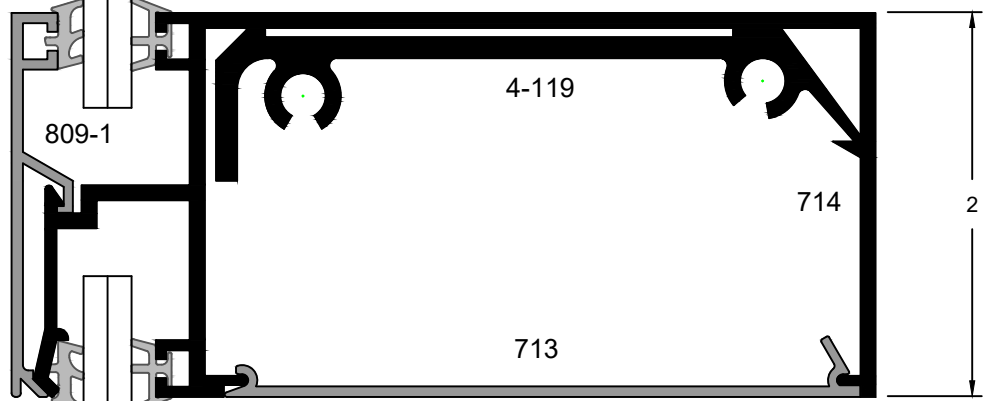

**Sill Can**

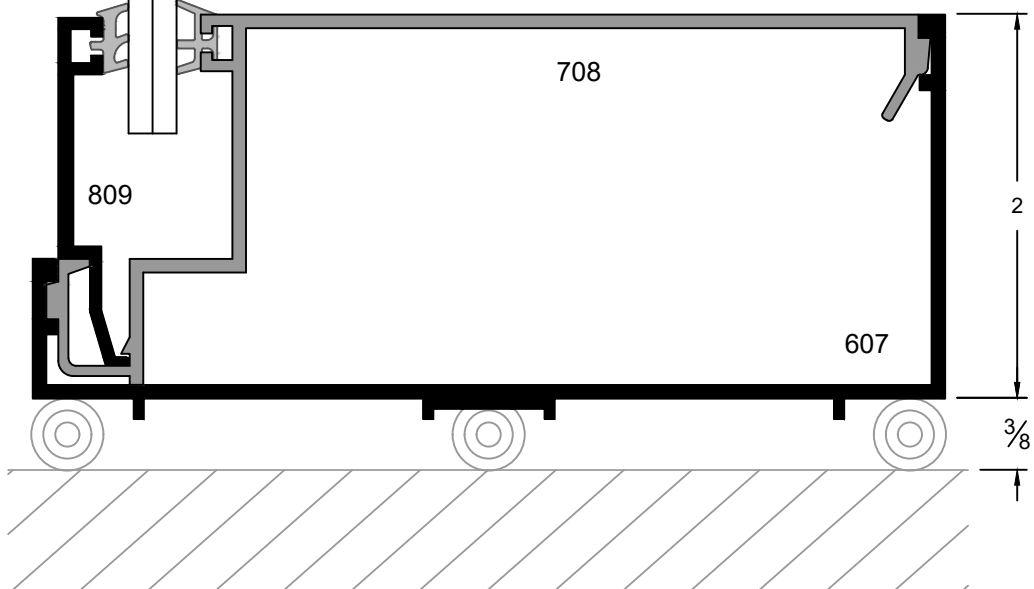

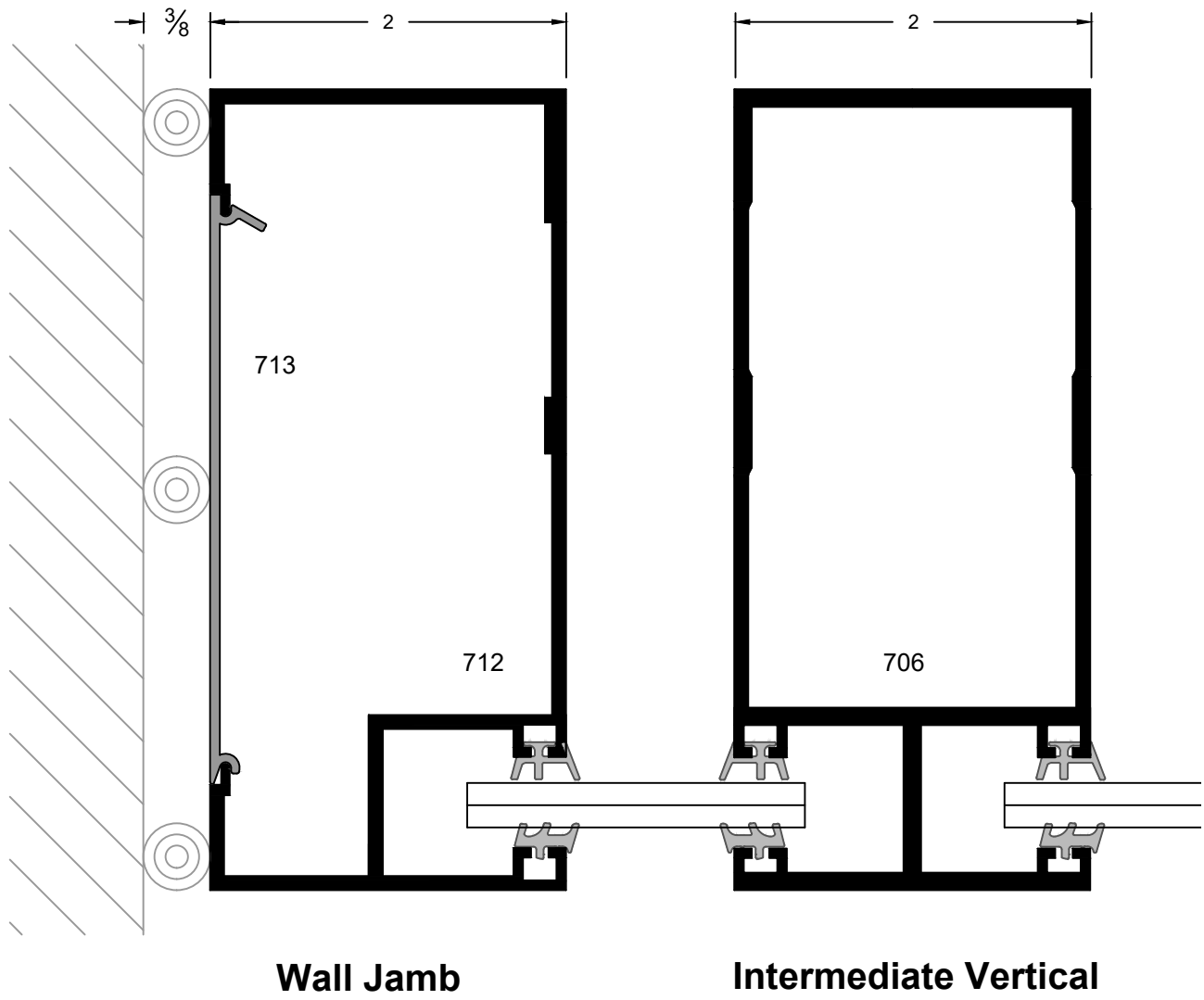

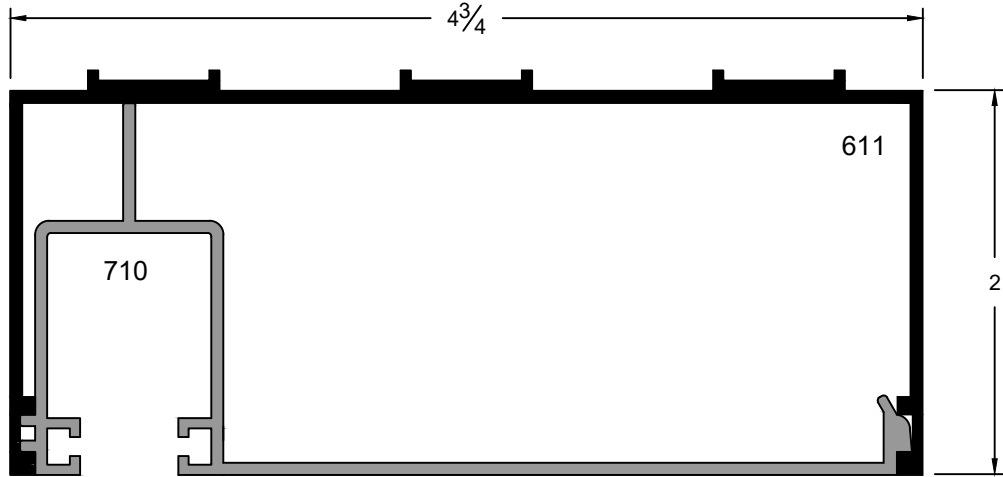

**Head Can Assembly**

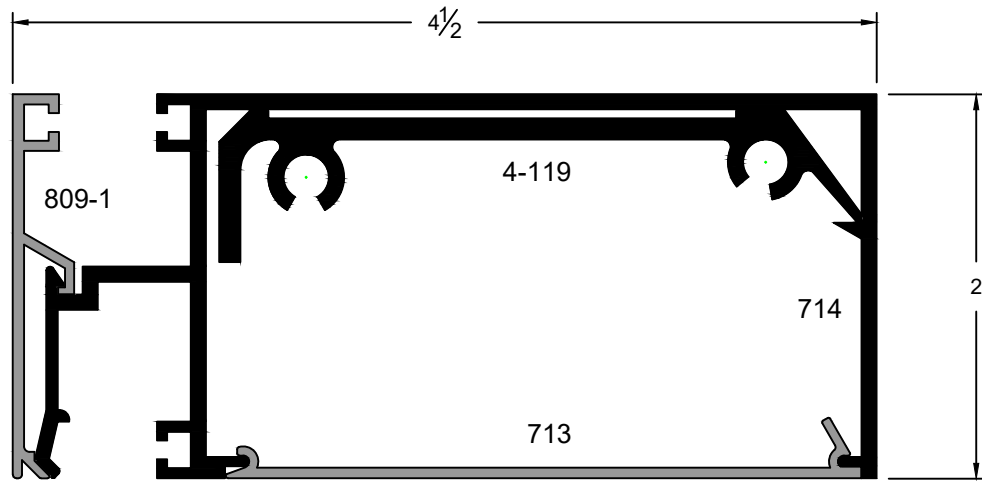

**Horizontal Assembly**

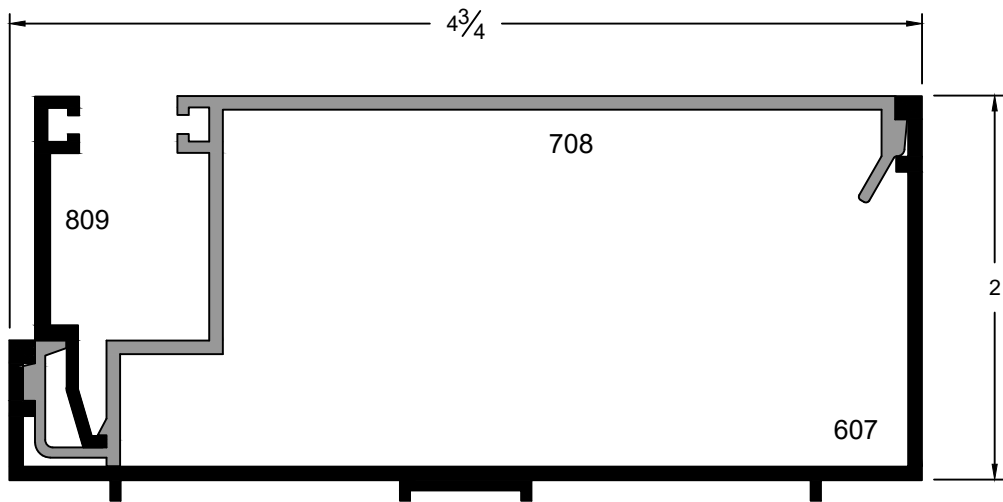

**Sill Can Assembly**

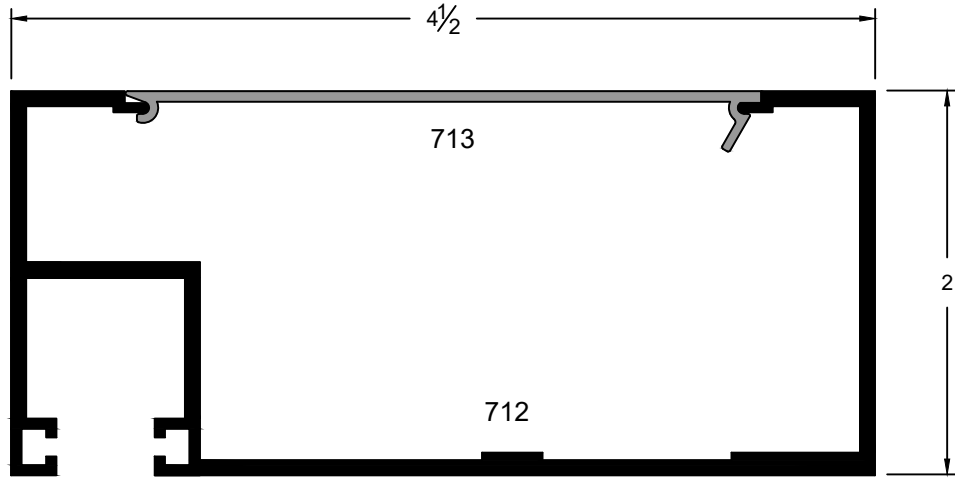

**Wall Jamb Assembly**

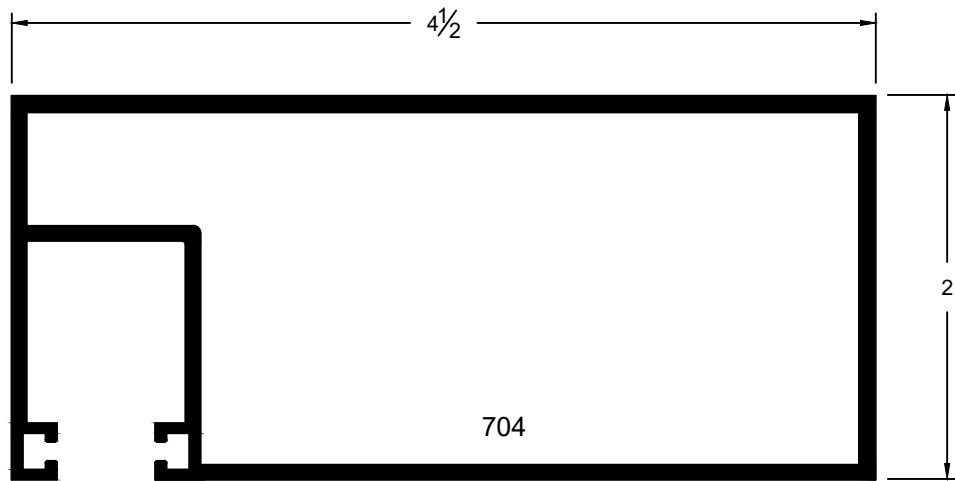

**Vertical**

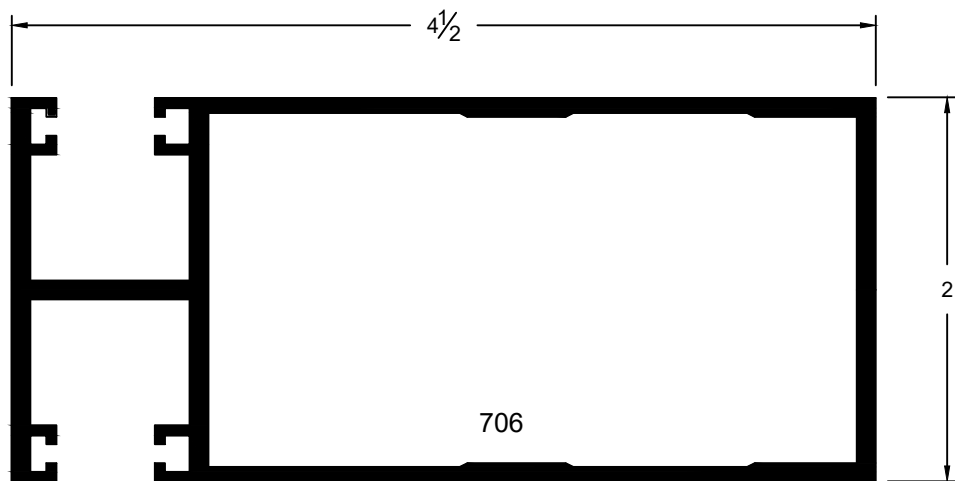

**Intermediate Vertical**

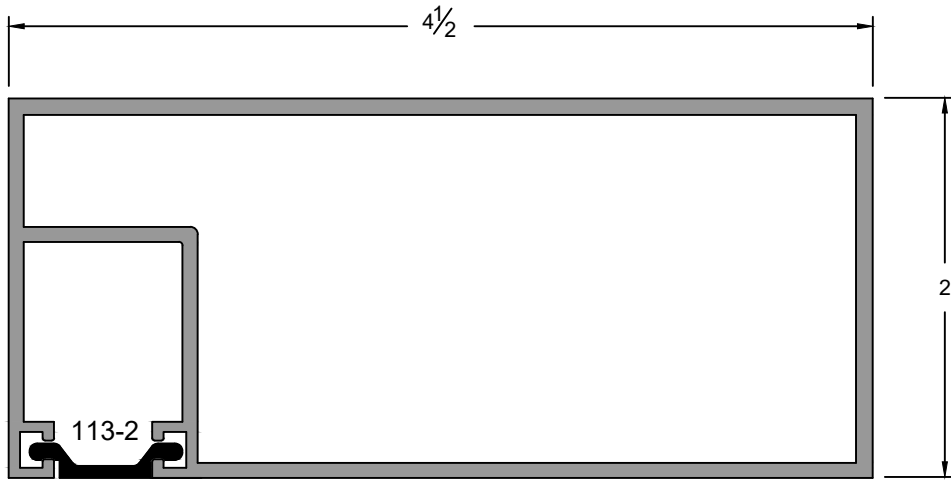

**Pocket Filler**



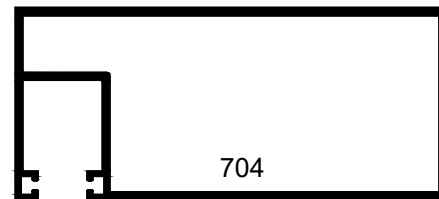
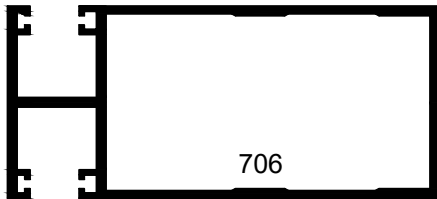
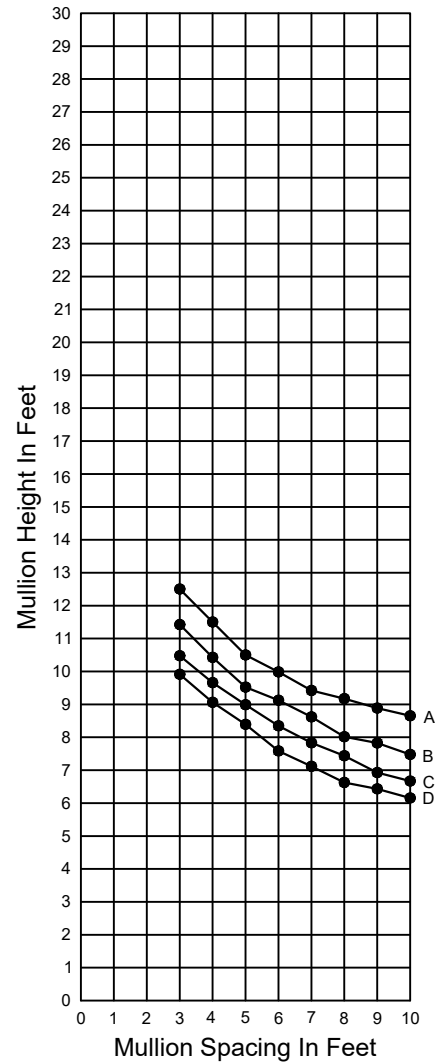
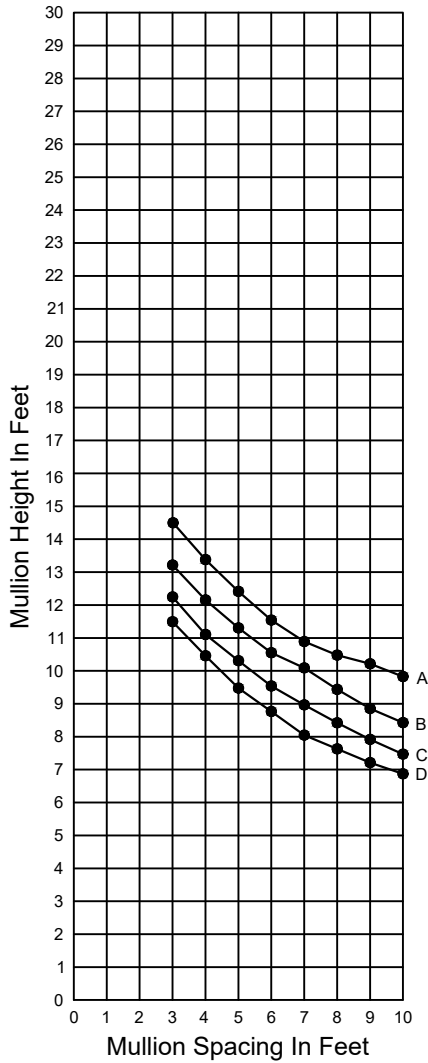

Curve Representation : A = 15 PSF  
 B = 20 PSF  
 C = 25 PSF  
 D = 30 PSF