

Head Can Assembly

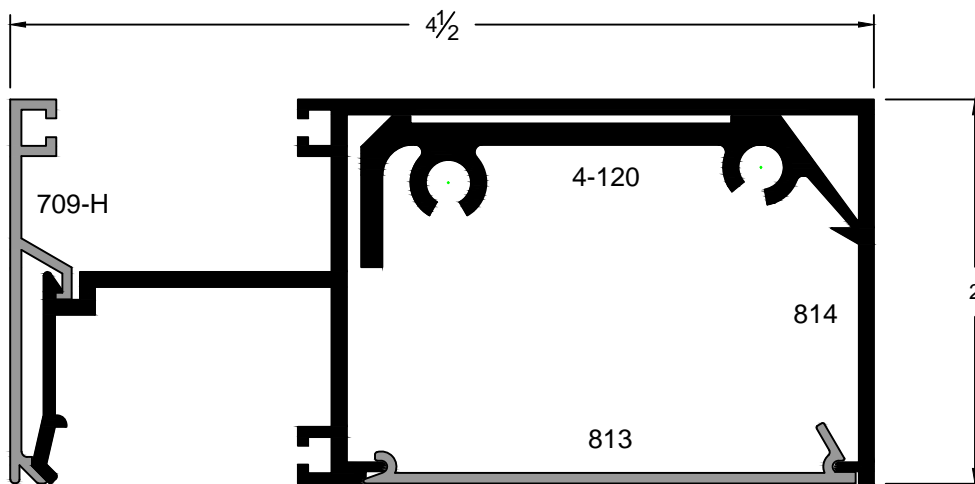

Horizontal Assembly

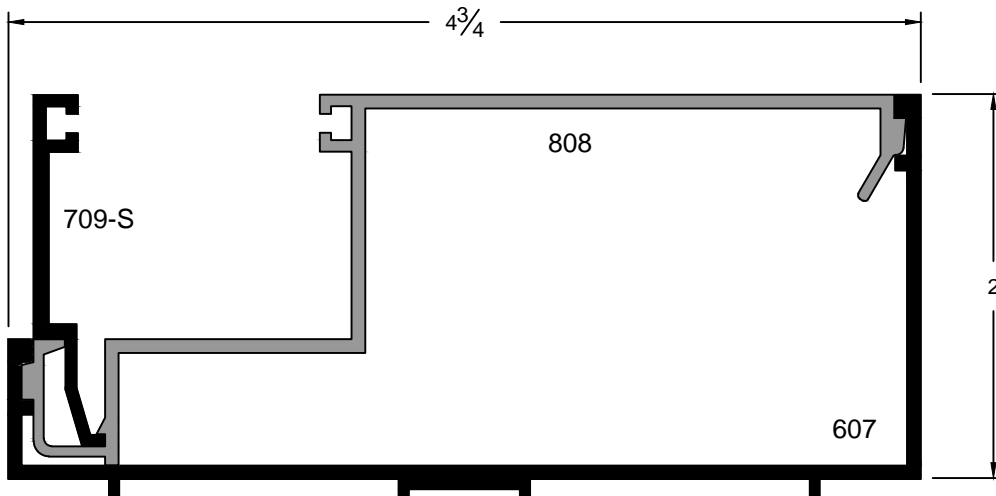

Sill Can Assembly

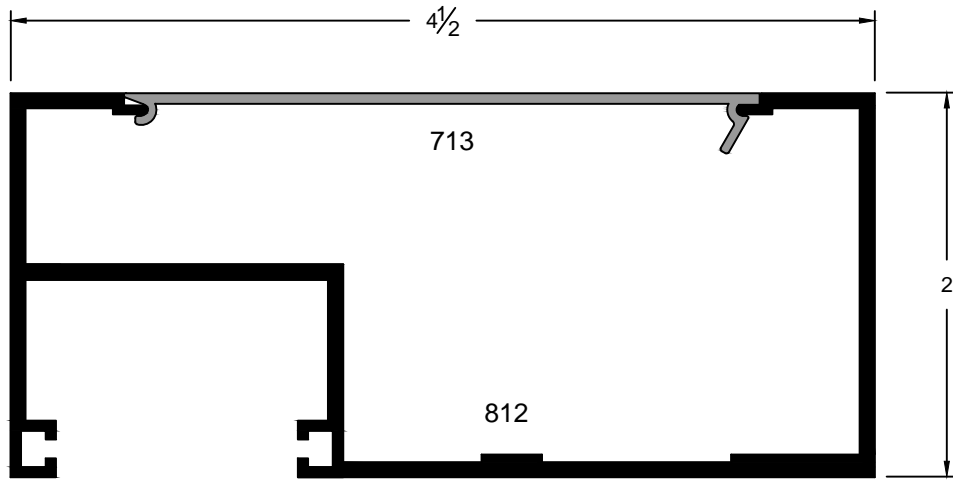

Wall Jamb Assembly

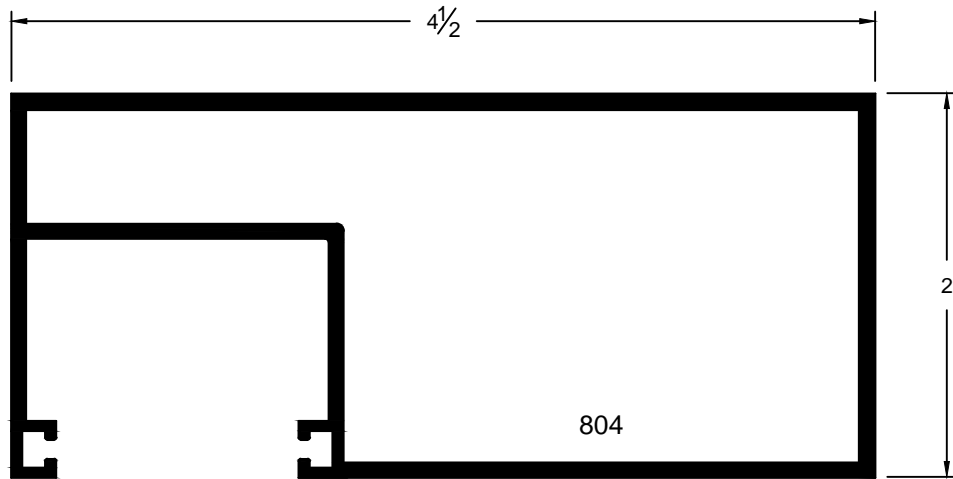

Vertical

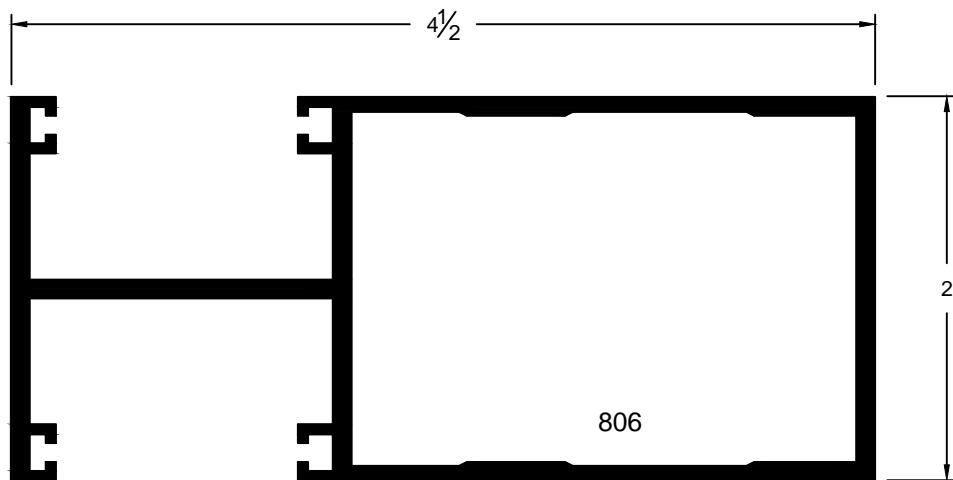

Intermediate Vertical

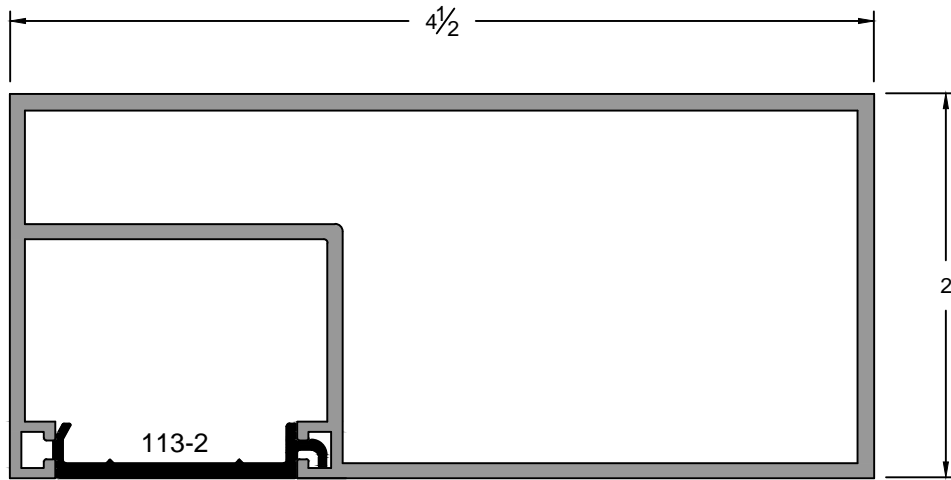

Pocket Filler

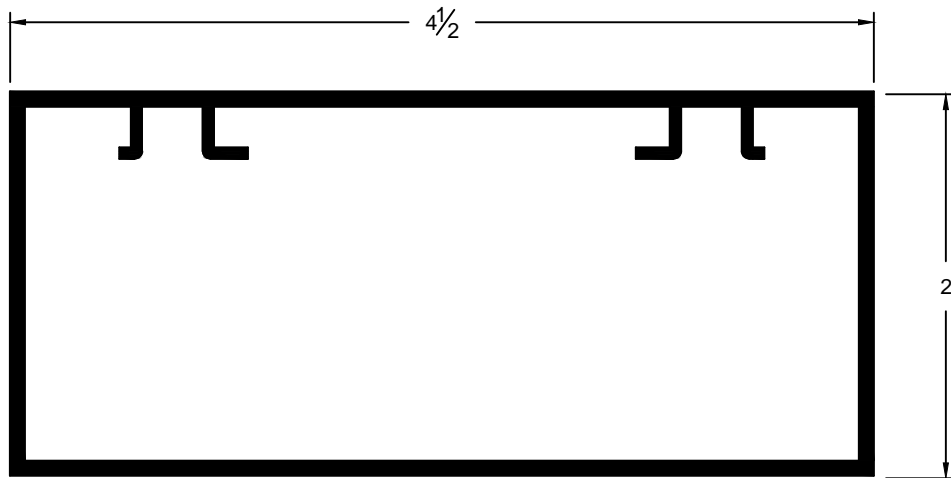

Header